

CERTIFICATE OF COMPLIANCE

**Regulation : FCC Part15B – Scanning Receiver
 Industry Canada RSS-215 Issue 1**

**: FCC Part15B Class B
 CANADA ICES-003 Class B**

Applicant	Testing Laboratory
Vertex Standard Co., Ltd. 4-8-8 Nakameguro Meguro-ku, Tokyo 153-8644 Japan Tel : +81 3 5725 6111 Fax : +81 3 5725 6225	ETL SEMKO Japan K.K. Kashima Site 3-2 Sunayama, Kamisu, Ibaraki 314-0255 Japan Tel.: +81 479 40 1097 Fax.: +81 479 46 1788 URL: http://www.japan.intertek-etlsemko.com

Equipment Type	HF Transceiver
Category	Scanning Receiver & Peripherals
Trademark	YAESU
Model (s)	FT-2000
Serial No.	6G000001
FCC ID	K6620251X50
IC	511B-20251X50
Test Result	Complied
Report Number	ESJ-106074
Report Issue Date	May 31, 2006

This equipment has been shown to be capable of compliance with the applicable standard(s) as indicated in the test report. I attest to the accuracy of data. All measurements reported herein were performed by me or were made under my supervision and are correct to the best of my knowledge and belief. I assume full responsibility for the completeness of these measurements and vouch for the qualifications of all persons taking them.

This test report shall not be reproduced partially, or in full, without the prior written approval of ETL SEMKO Japan K.K. The results and statements contained in this report pertain only to the equipment evaluated.

Approved by

Tested by



 Kazuo Gokita
 [Assistant Manager]

 Kazuo Masuda

TABLE OF CONTENTS

	Page
SECTION 1. GENERAL INFORMATION	3
SECTION 2. SUMMARY OF TEST RESULTS	4
SECTION 3. INFORMATION ABOUT EUT	5
SECTION 4. SUPPORT EQUIPMENT(S).....	7
SECTION 5. USED CABLE (S).....	8
SECTION 6. CONSTRUCTION OF EQUIPMENT	10
SECTION 7. OPERATING CONDITION.....	12
SECTION 8. TEST PROCEDURE(S).....	13
SECTION 9. EVALUATION OF TEST RESULTS.....	18
SECTION 10. LIST OF MEASURING INSTRUMENTS	41
SECTION 11. MEASUREMENT UNCERTAINTY	43
SECTION 12. DESCRIPTION OF TEST LABORATORY	44

SECTION 1. GENERAL INFORMATION

TEST PERFORMED

Location	Kashima No.1 Test Site (FCC Reg. : 934283) (IC File No. : IC 2065-1)
EUT Received	May 22, 2006
Test Started	May 22, 2006
Test Completed	May 24, 2006
Standard Applied	FCC Part15B – Scanning Receiver Industry Canada RSS-215 Issue 1 FCC Part15B Class B - Peripherals and Canada ICES-003 Class B
Test Setup	ANSI C63.4-2003
Deviation from Standard (s)	No deviation

TEST TRACEABILITY

Traceability to national standards of test result is achieved by means of calibration traceability to national or international standards.

LIMITATIONS ON RESULTS

The test result of this report is effective for equipment under test itself and under the test configuration described on the report.

This test report does not assure that whether the test result taken in other testing laboratory is compatible or reproducible to the test result on this report or not.

ABBREVIATIONS

AE = Associated Equipment

AMN = Artificial Mains Network

AMP = Amplifier, ATT = Attenuator

ANT = Antenna, BBA = Broadband Antenna

AVG = Average

Cal = Calibration

CDN = Coupling Decoupling Network

LCD = Liquid-Crystal Display

SPKR = Speaker

DIP = Dipole Antenna

DoC = Device for Declaration of Conformity

EUT = Equipment Under Test

ISN = Impedance Stabilization Network

LISN = Line Impedance Stabilization Network

PK = Peak

Q-P = Quasi-peak

RX = Receive

SECTION 2. SUMMARY OF TEST RESULTS

This test report clearly shows that the EUT is in compliance with the **FCC Part15B** (- Scanning Receiver with Industry Canada RSS-215) and **FCC Part15B Class B** (- Peripheral with Canada ICES-003 Class B) specification.

The minimum margins to the limits are as follows:

Conducted Voltages on Mains Port	RX 0.030MHz mode	9.4 dB	at	0.3975 MHz
Radiated Electric Field	RX 60MHz mode	8.6 dB	at	576.05 MHz
Conducted Power on Antenna Port	RX 60MHz mode (ANT2)	22.6 dB	at	1808.24 MHz
38dB Rejection Test (15.121(b))	No frequency of response was detected. - Passed -			

Note : See Section 9 for details.

SECTION 3. INFORMATION ABOUT EUT

The equipment under test (EUT) consisted of the following equipment.

3.1 List of System Configuration

Symbol	Item	Model No.	Serial No.	Manufacturer	Notes	FCC ID
A1	HF Transceiver	FT-2000	6G000001	Vertex Standard	EUT	K6620251X50
A2	Microphone	MH-31B8	None	Vertex Standard	EUT	N.A.
A3	Headphone	YH-77STA	None	Vertex Standard	Option	N.A.
A4	Speaker	SP-8	None	Vertex Standard	Option	N.A.
Power Ratings of EUT : AC 100 - 120V, 50 - 60Hz, 6A						
Power Supply : AC 120V, 60 Hz						
Condition of Equipment	Prototype					
Type	Tabletop					
Suppression Devices	No Modifications by the laboratory were made to the device					

3.2 Overview of EUT :

Frequency Ranges	0.030 – 60.000 MHz
Receiver Type	Triple Conversion Super-heterodyne
Mode of Operation	A1A, A3E, F3E, J3E

3.3 Intermediate Frequencies :

1st	69.45 MHz (Upper)
2nd	0.450 MHz (Lower)
3rd	24 kHz (FM and AM modes, Lower), 30kHz (Other modes, Lower)

3.4 Oscillator(s) / Crystal (s) :

Oscillator	Operating Frequency	Board Name	Notes
11.1 MHz	11.1 MHz	CNTL Unit	Microprocessor
16.0 MHz	16.0 MHz	TUNER-CNTL Unit	Microprocessor
18.432 MHz	18.432 MHz	DSP Unit	Microprocessor
25.0 MHz	25.0 MHz	DSP Unit	Microprocessor
69.48 - 129.45 MHz	69.48 – 129.45 MHz	LOCAL Unit	LOCAL Oscillator (Highest)
40.485 – 100.455 MHz	40.485 – 100.455 MHz	LOCAL Unit	LOCAL Oscillator
69.0 MHz	69.0 MHz	LOCAL Unit	LOCAL Oscillator
40.0 MHz	40.0 MHz	LOCAL Unit	LOCAL Oscillator
420 kHz or 426kHz	420 kHz or 426kHz	LOCAL Unit	LOCAL Oscillator
35.4 MHz	35.4 MHz	LOCAL Unit	Reference OSC

3.5 Port(s)/Connector(s) :

Port Name	Connector Type	Connector Pin	Notes
MIC	FM214-8SMPT-NI	8pin	
PHONES	6φ Stereo	1pin	
KEY	6φ Stereo	1pin	Front
ANT1, 2, RX ANT IN	MR-S (Coaxial)	1pin	
RX ANT OUT	BNC	1pin	
u-TUNE (to)	RCA	1pin	
u-TUNE (from)	RCA	1pin	
ROT	Mini-DIN	6pin	
BAND DATA	DIN	8pin	
PACKET	DIN	4pin	
RTTY	DIN	4pin	
PTT	RCA	1pin	
TRV	RCA	1pin	
EXT ALC	RCA	1pin	
TX GND	RCA	1pin	
MIC	RCA	1pin	
REC	RCA	1pin	
TX REQ	RCA	1pin	
+13.8V	RCA	1pin	
AF OUT	3.5φ Mono	1pin	
REM	3.5φ Mono	1pin	
EXT SPKR	3.5φ Mono	1pin	
u-TUNE	Mini-DIN	10pin	
DMU	Mini-DIN	9pin	
PGM	Mini-DIN	8pin	
CAT	D-sub	9pin	
KEY	6φ Stereo	1pin	Rear

3.6 Frequency Range of Measurements

	Measured Frequency Range
Conducted Voltages on Mains Port	0.15 – 30 MHz
Radiated Electric Field	30 – 2000 MHz
Conducted Power on Antenna Port	30 – 2000 MHz
38dB Rejection	0.030 – 60 MHz

SECTION 4. SUPPORT EQUIPMENT(S)

The EUT was supported by the following equipment during the test.

Symbol	Item	Model No.	Serial No.	Manufacturer	FCC ID / DoC	Note
B	Computer	MCM	JDD151S	Dell Computer	DoC	
C	LCD Monitor	E152FPc	CN-0N1546-64180-443-12QH	Dell Computer	DoC	
D	Keyboard	SK-8110	CN-0C6227-71616-46O-05B7	Dell Computer	DoC	
E	Mouse	MO71KC	427076743	Dell Computer	DoC	
F	Printer	C6490B	MY35G1R1KT	Hewlett Packard	DoC	
G	AC Adapter	ADP-32BBA	PLT031803	Hewlett Packard	N.A.	
Power Supply :						
B, C, G	AC120V, 60Hz					

SECTION 5. USED CABLE (S)

The following cable(s) was used for the test.

No.	Name	Length (m)	Shield	Connector Type	Ferrite Core
1	Microphone cable	0.5 m	Yes	Metal	
2	Headphone cable	1.5 m	Yes	Metal	
3	KEY cable	1.5 m	Yes	Metal	
4	u-TUNE (to) cable	1.5 m	No	Metal	
5	u-TUNE (from) cable	1.5 m	Yes	Metal	
6	ROT cable	1.5 m	Yes	Metal	
7	BAND DATA cable	1.5 m	Yes	Metal	
8	PACKET cable	1.5 m	Yes	Metal	
9	RTTY cable	1.5 m	Yes	Metal	
10	PTT cable	1.5 m	Yes	Metal	
11	TRV cable	1.0 m	Yes	Metal	
12	EXT ALC cable	1.0 m	Yes	Metal	
13	TX GND cable	1.5 m	Yes	Metal	
14	MIC cable	1.5 m	Yes	Metal	
15	REC cable	1.5 m	Yes	Metal	
16	TX REQ cable	1.5 m	Yes	Metal	
17	+13.8V cable	1.0 m	Yes	Metal	
18	AF OUT cable	1.5 m	Yes	Metal	
19	REM cable	1.5 m	Yes	Metal	
20	EXT SPKR cable	1.0 m	Yes	Metal	
21	u-TUNE cable	1.5 m	Yes	Metal	
22	DMU cable	1.5 m	Yes	Metal	
23	PGM cable	0.5 m	Yes	Metal	
24	RS-232C cable	2.8 m	Yes	Metal	
25	KEY cable	1.5 m	Yes	Metal	
26	Centronics cable	1.7 m	Yes	Metal	
27	Video cable	1.8 m	Yes	Metal	
28	Keyboard cable	2.0 m	Yes	Metal	
29	Mouse cable	1.8 m	Yes	Metal	

No.	Name	Length (m)	Shield	Connector Type	Ferrite Core
30	Power cable for EUT	1.7 m	No	-	
31	Power cable for Computer	1.9 m	No	-	
32	Power cable for LCD Monitor	1.8 m	No	-	
33	Power cable for Printer (DC)	1.7 m	No	-	Fixed ×1
34	Power cable for Printer (AC)	2.0 m	No	-	

Note :

SECTION 6. CONSTRUCTION OF EQUIPMENT

6.1 Conducted Voltages on Mains Port Radiated Electric Field

System configuration

* : EUT
 ■ : Ferrite core

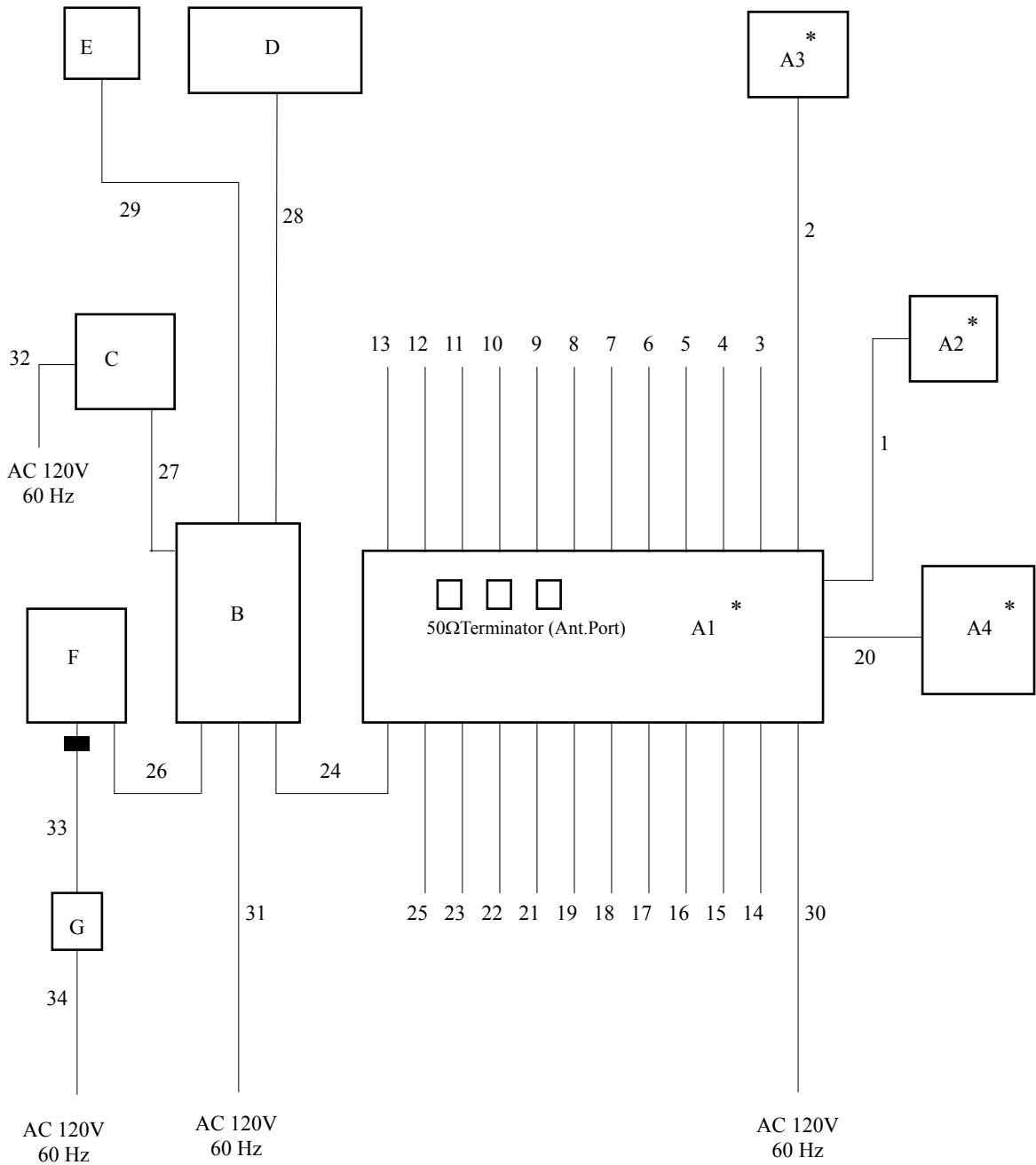

The symbols and numbers assigned to the equipments and cables on this diagram correspond to the ones in Sections 3 to 5.

6.2 Conducted Power on Antenna Port

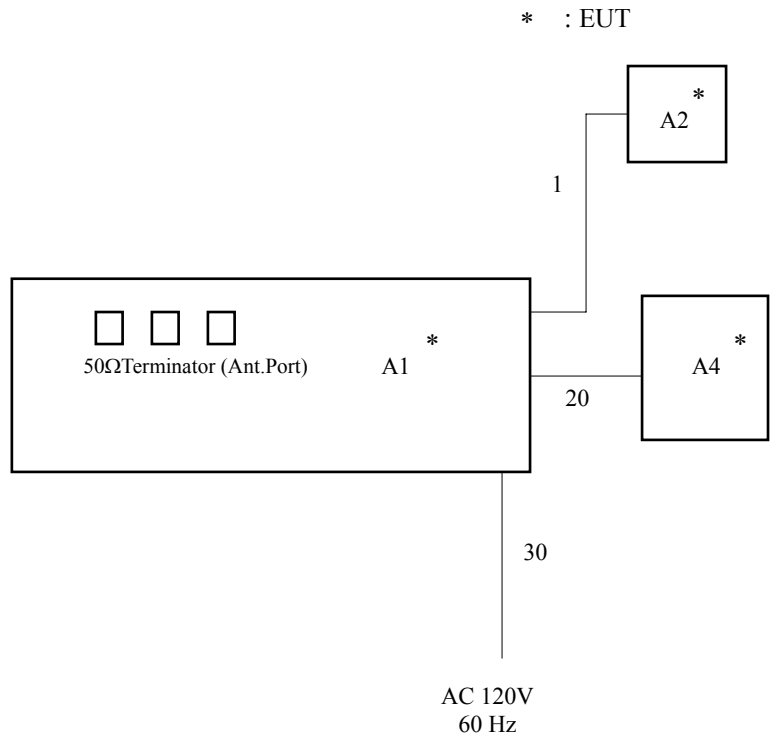

6.3 38dB Rejection

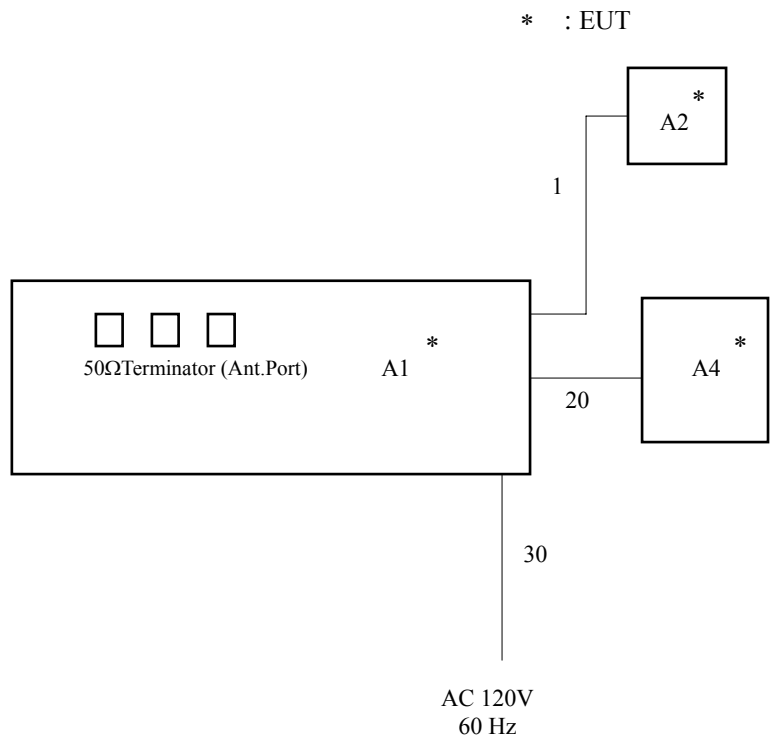

The symbols and numbers assigned to the equipments and cables on this diagram correspond to the ones in Sections 3 to 5.

SECTION 7. OPERATING CONDITION

The EUT was operated under the following conditions during the test.

7.1 Operating Condition

The test was carried out under RX mode and VFO Scan mode.
EUT was examined in the operating conditions that had maximum emissions.

7.2 Operating Flow [RX mode and VFO Scan mode]

Following operations were performed continuously.

7.2.1 RX mode

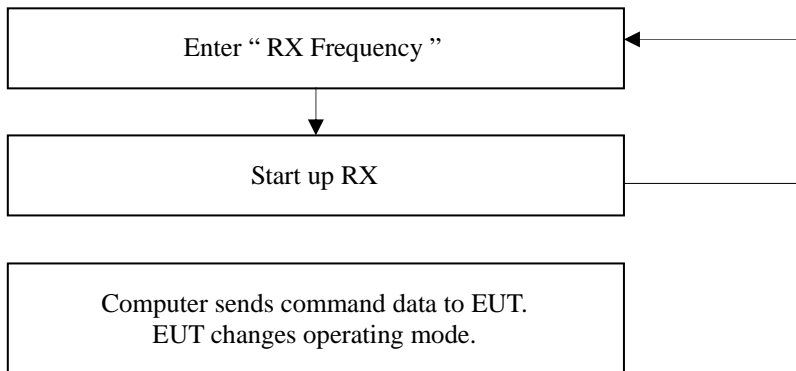

7.2.2 VFO Scan mode

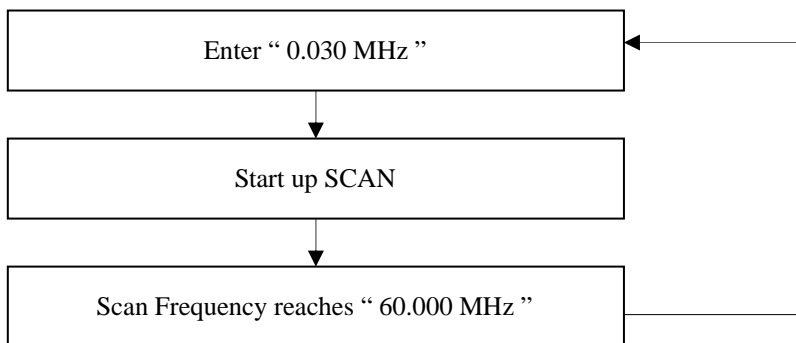

SECTION 8. TEST PROCEDURE(S)

Test was carried out under the following conditions.

Conducted Voltages on Mains Port

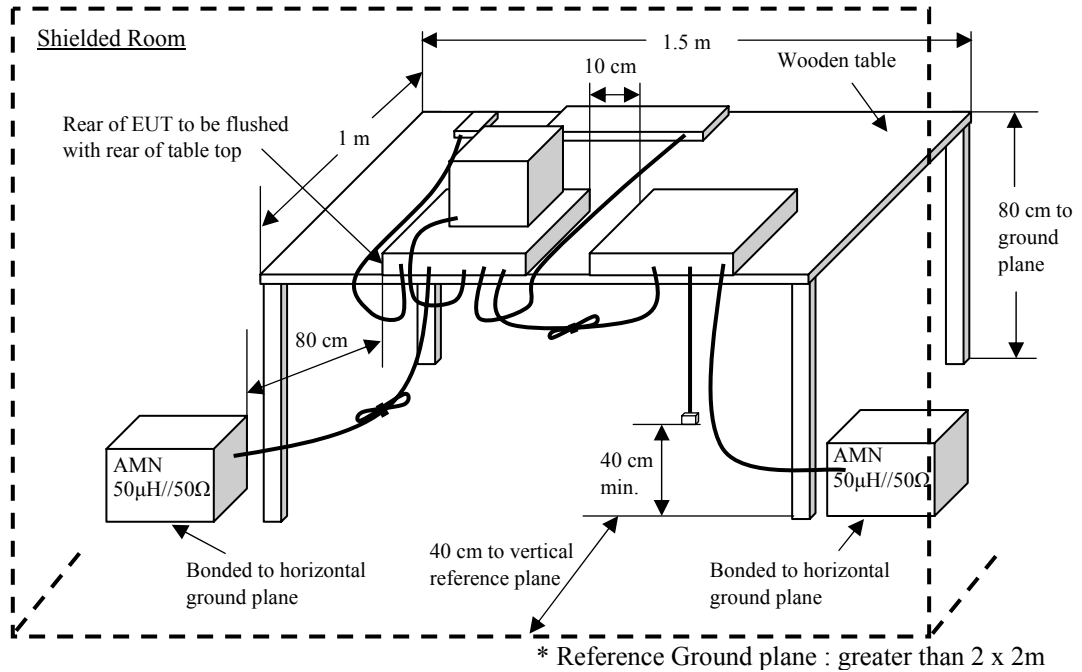

Schema for the conducted voltages on mains port measurement

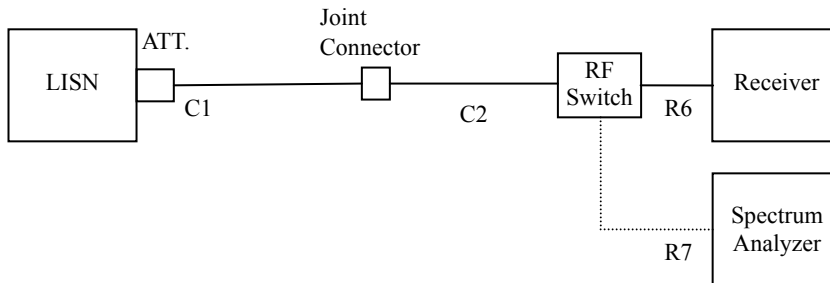

[Instrument Setup]

Frequency [MHz]	Instrument	Detector Function	Resolution Bandwidth	Video Bandwidth
0.15 – 30	Receiver	Quasi Peak	10 kHz	N.A.
		Average	10 kHz	N.A.

[Preliminary Measurement]

EUT is tested on all operating conditions.

The spectrum analyzer is controlled by the computer program to sweep the frequency range to be measured, then spectrum chart are plotted out to find the worst emission conditions in operating mode and/or configuration decision for the final test.

All leads other than safety ground are tested.

[Final Measurement]

The EUT is operated in the worst emission condition found by the preliminary test.

The equipment and cables are arranged or manipulated within the range of the test standard in the above condition.

At least six highest spectrum are measured in quasi-peak and average (if necessary) using the test receiver.

Radiated Electric Field

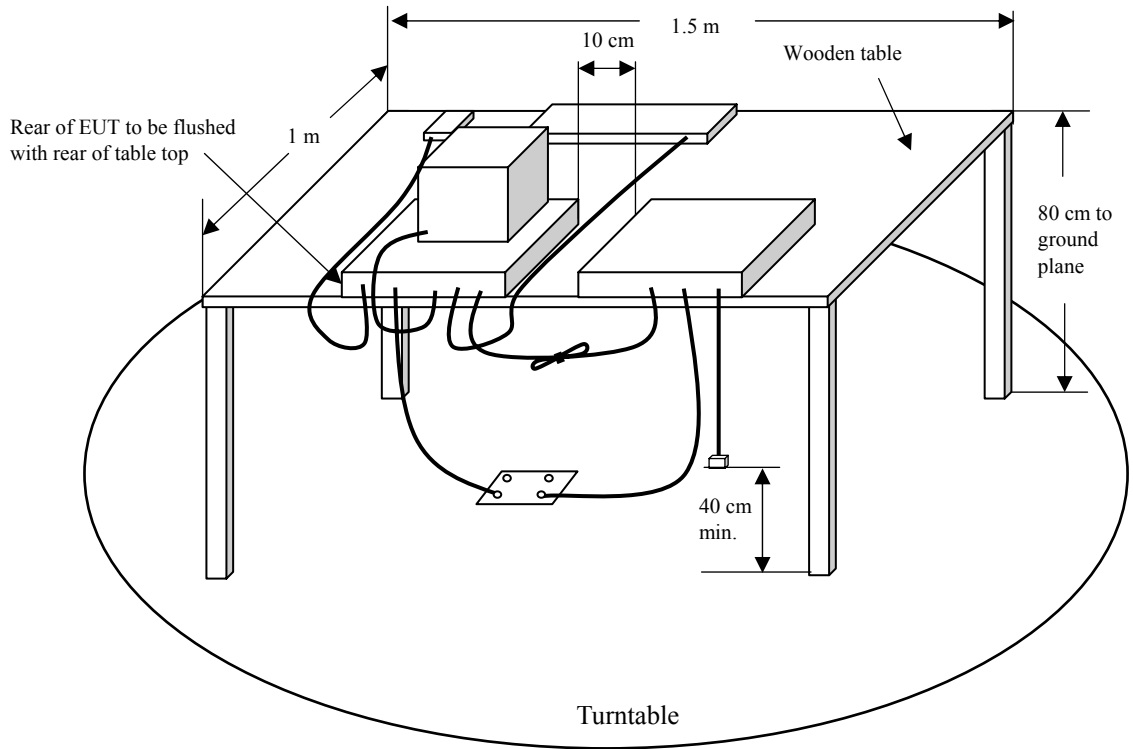

Schema for the radiated electric field measurement (30-1000MHz)

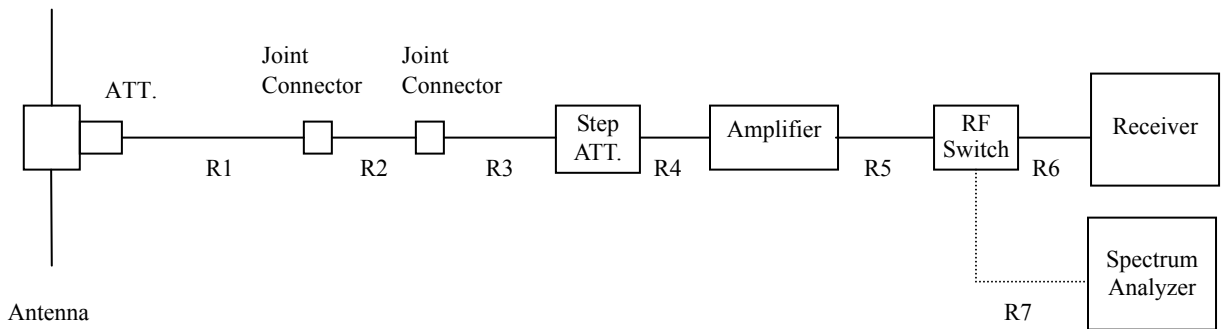

Above 1GHz

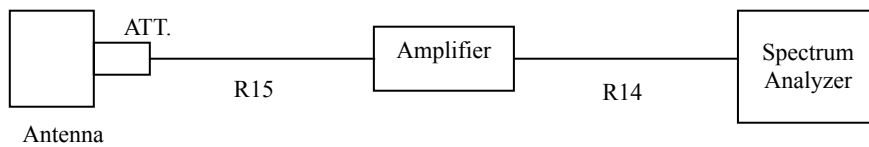

[Instrument Setup]

Frequency [MHz]	Instrument	Detector Function	Resolution Bandwidth	Video Bandwidth
30 to 1000	Receiver	Quasi Peak	120 kHz	N.A.
Above 1000	Spectrum Analyzer	Peak	1 MHz	1 MHz
		Average	1 MHz	10 Hz

[Preliminary Measurement]

EUT is tested on all operating conditions.

The spectrum analyzer is set max-hold mode and swept during turntable was rotated 0 to 360 degree. Then spectrum chart are plotted out to find the worst emission conditions in configuration, operating mode, or ambient noise notation.

[Final Measurement]

The EUT operated in the worst emission condition found by the preliminary test.

The turntable azimuth (EUT direction) and antenna height (1 to 4 meters) are adjusted the position so that maximum field strength is obtained for each frequency spectrum to be measured.

The equipment and cables are arranged or manipulated within the range of the test standard in the above condition.

At least six highest spectrum are measured by the test receiver (quasi-peak) and spectrum analyzer (peak and average). When the uncertain result was obtained, the measurement is retried by using the half wave dipole antenna instead of the broadband antenna.

Conducted Power on Antenna port

Schema for the conducted power on antenna port measurement

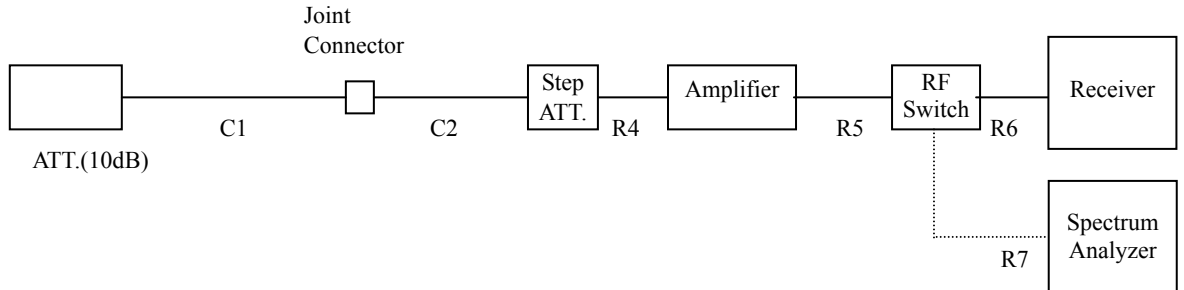

Above 1GHz

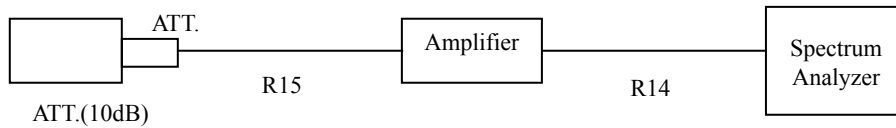

[Instrument Setup]

Frequency [MHz]	Instrument	Detector Function	Resolution Bandwidth	Video Bandwidth
30 to 1000	Receiver	Quasi Peak	120 kHz	N.A.
Above 1000	Spectrum Analyzer	Peak	1 MHz	1 MHz
		Average	1 MHz	10 Hz

[Preliminary Measurement]

EUT is tested on all operating conditions.

The spectrum analyzer is controlled by the computer program to sweep the frequency range to be measured, then spectrum chart are plotted out to find the worst emission conditions in operating mode and/or configuration decision for the final test.

[Final Measurement]

The EUT is operated in the worst emission condition found by the preliminary test.

The equipment and cables are arranged or manipulated within the range of the test standard in the above condition.

At least six highest spectrum are measured in quasi-peak using the test receiver.

38dB Rejection

Schema for the 38dB rejection measurement



[Preliminary Measurement]

The Signal Generator conditions :

Output level = 66 dBuV.

Modulation = Frequency modulated to 1 kHz tone at 3 kHz peak deviation.

Frequency Points = 824.040 MHz, 836.505 MHz, 848.970 MHz
869.040 MHz, 881.505 MHz, 893.970 MHz

(The Cellular Radiotelephone Service mobile and base frequency bands)

The EUT condition :

Scanning Frequency = 0.030 MHz – 60.000 MHz (5 kHz Step).

Scan stopped point, was the detected frequency.

[Final Measurement]

Injected 12dB SINAD Reading (SG RF Output)

The EUT condition :

Frequency = Scan stopped point

The Signal Generator condition :

Frequency = Cellular point

Detected 12dB SINAD Reading (SG RF Output)

The EUT condition :

Frequency = Scan stopped point

The Signal Generator condition :

Frequency = Scan stopped point

Under the requirements of Section 15.121(b) of the Rule.

Injected 12dB SINAD Reading – Detected 12dB SINAD Reading = 38 dB or more.

SECTION 9. EVALUATION OF TEST RESULTS

9.1 Conducted Voltages on Mains Port

9.1.1 RX 0.030MHz mode

ETL SEMKO Japan K.K
Kashima No.1 Test Site
Conducted Voltages on Mains Port

APPLICANT : Vertex Standard Co., Ltd.
 EUT NAME : HF Transceiver
 MODEL NO. : FT-2000
 SERIAL NO. : 6G000001
 TEST MODE : RX 0.030MHz (ANT1)
 POWER SOURCE : AC120V/60Hz
 DATE TESTED : May 23 2006
 FILE NO. : ESJ-106074
 REGULATION : FCC Part15B Class B
 TEST METHOD : ANSI C63.4-2003
 TEMPERATURE : 21.0 [degC]
 HUMIDITY : 60.0 [%]
 NOTE :

ENGINEER : Kazuo Masuda

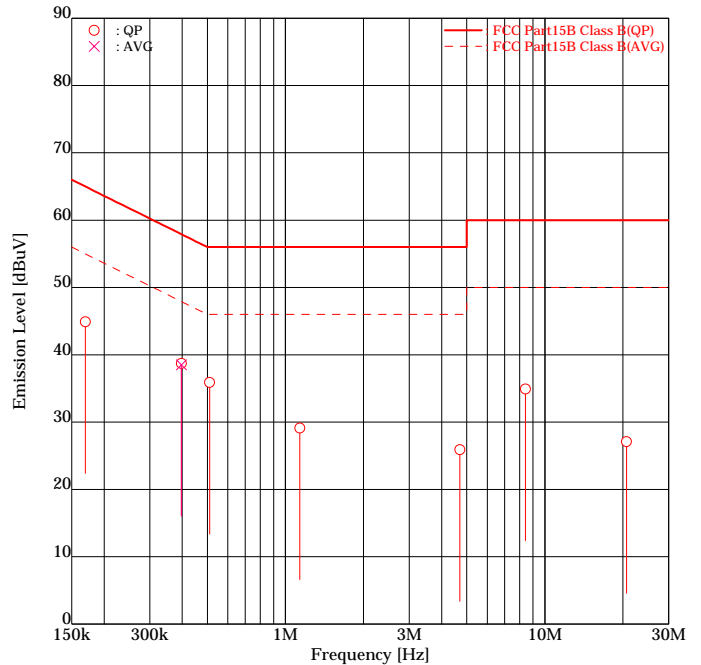

FREQUENCY [No]	MODE [MHz]		READING [dBuV]		FACTOR [dB]		EMISSION [dBuV]		LIMIT [dBuV]	MARGIN [dB]	
			Line1	Line2	Line1	Line2	Line1	Line2		Line1	Line2
1	0.1694	QP	38.1	<u>39.2</u>	5.7	5.7	43.8	<u>44.9</u>	65.0	21.2	<u>20.1</u>
2	0.3975	QP	30.0	<u>33.0</u>	5.7	5.7	35.7	<u>38.7</u>	57.9	22.2	<u>19.2</u>
3	0.3975	AVG	29.9	<u>32.8</u>	5.7	5.7	35.6	<u>38.5</u>	47.9	12.3	<u>9.4</u>
4	0.5100	QP	27.2	<u>30.2</u>	5.8	5.7	33.0	<u>35.9</u>	56.0	23.0	<u>20.1</u>
5	1.1361	QP	21.4	<u>23.2</u>	5.9	5.9	27.3	<u>29.1</u>	56.0	28.7	<u>26.9</u>
6	4.7061	QP	20.0	20.1	5.9	5.8	25.9	25.9	56.0	30.1	30.1
7	8.4243	QP	<u>28.9</u>	27.9	6.0	6.0	<u>34.9</u>	33.9	60.0	<u>25.1</u>	26.1
8	20.6392	QP	20.8	20.2	6.3	6.6	27.1	26.8	60.0	32.9	33.2

Higher six points are underlined.
 Other frequencies : Below the FCC Part15B Class B limit
 Emission Level = Read + Factor(LISN,Pad,Cable)

9.1.2 RX 30MHz mode

ETL SEMKO Japan K.K
Kashima No.1 Test Site
Conducted Voltages on Mains Port

APPLICANT : Vertex Standard Co., Ltd.
 EUT NAME : HF Transceiver
 MODEL NO. : FT-2000
 SERIAL NO. : 6G000001
 TEST MODE : RX 30MHz (ANT1)
 POWER SOURCE : AC120V/60Hz
 DATE TESTED : May 23 2006
 FILE NO. : ESJ-106074
 REGULATION : FCC Part15B Class B
 TEST METHOD : ANSI C63.4-2003
 TEMPERATURE : 21.0 [degC]
 HUMIDITY : 60.0 [%]
 NOTE :

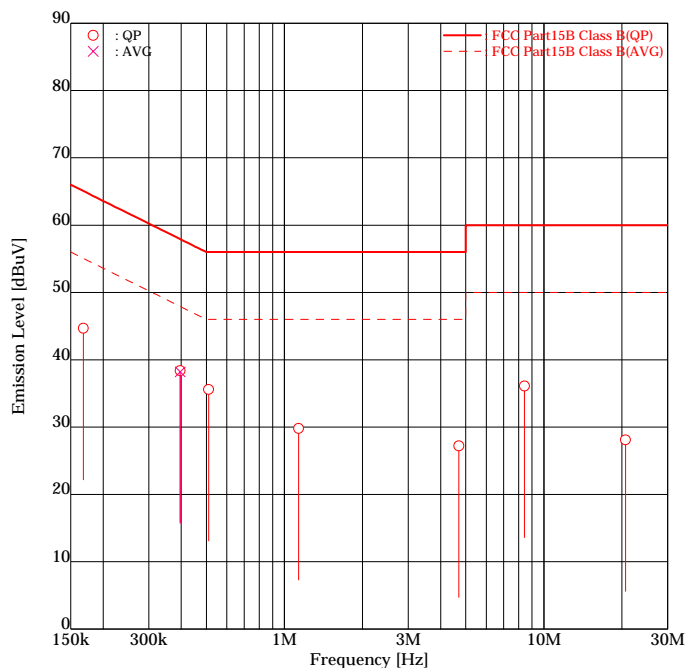

ENGINEER : Kazuo Masuda

FREQUENCY [No]	MODE [MHz]		READING [dBuV]		FACTOR [dB]		EMISSION [dBuV]		LIMIT [dBuV]	MARGIN [dB]	
			Line1	Line2	Line1	Line2	Line1	Line2		Line1	Line2
1	0.1680	QP	37.4	<u>39.0</u>	5.7	5.7	43.1	<u>44.7</u>	65.1	22.0	<u>20.4</u>
2	0.3968	QP	29.8	<u>32.7</u>	5.7	5.7	35.5	<u>38.4</u>	57.9	22.4	<u>19.5</u>
3	0.3968	AVG	29.7	<u>32.5</u>	5.7	5.7	35.4	<u>38.2</u>	47.9	12.5	<u>9.7</u>
4	0.5098	QP	27.0	<u>29.9</u>	5.8	5.7	32.8	<u>35.6</u>	56.0	23.2	<u>20.4</u>
5	1.1343	QP	20.6	<u>23.9</u>	5.9	5.9	26.5	<u>29.8</u>	56.0	29.5	<u>26.2</u>
6	4.7068	QP	21.3	20.1	5.9	5.8	27.2	25.9	56.0	28.8	30.1
7	8.4242	QP	<u>30.1</u>	29.0	6.0	6.0	<u>36.1</u>	35.0	60.0	<u>23.9</u>	25.0
8	20.6396	QP	21.8	21.1	6.3	6.6	28.1	27.7	60.0	31.9	32.3

Higher six points are underlined.
 Other frequencies : Below the FCC Part15B Class B limit
 Emission Level = Read + Factor(LISN,Pad,Cable)

9.1.3 RX 60MHz mode

ETL SEMKO Japan K.K
Kashima No.1 Test Site
Conducted Voltages on Mains Port

APPLICANT : Vertex Standard Co., Ltd.
 EUT NAME : HF Transceiver
 MODEL NO. : FT-2000
 SERIAL NO. : 6G000001
 TEST MODE : RX 60MHz (ANT1)
 POWER SOURCE : AC120V/60Hz
 DATE TESTED : May 23 2006
 FILE NO. : ESJ-106074
 REGULATION : FCC Part15B Class B
 TEST METHOD : ANSI C63.4-2003
 TEMPERATURE : 21.0 [degC]
 HUMIDITY : 60.0 [%]
 NOTE :

ENGINEER : Kazuo Masuda

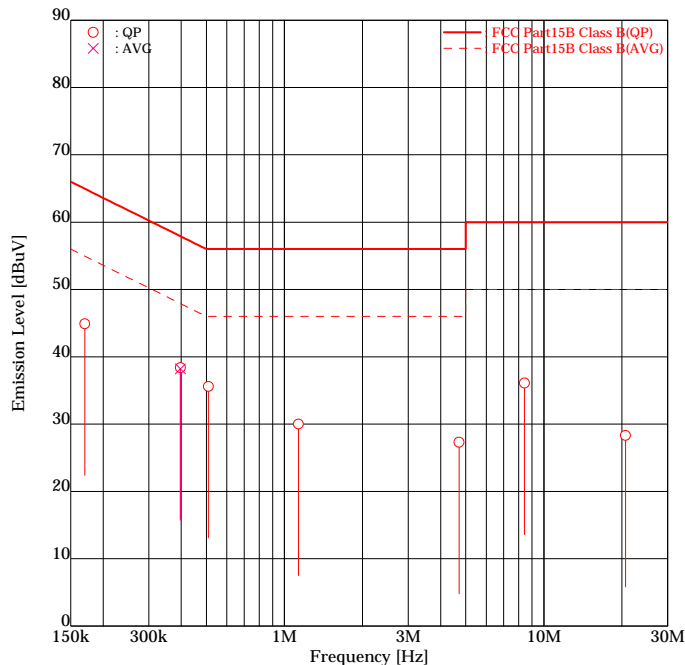

FREQUENCY [No]	MODE [MHz]		READING [dBuV]		FACTOR [dB]		EMISSION [dBuV]		LIMIT [dBuV]	MARGIN [dB]	
			Line1	Line2	Line1	Line2	Line1	Line2		Line1	Line2
1	0.1700	QP	37.6	<u>39.2</u>	5.7	5.7	43.3	<u>44.9</u>	65.0	21.7	<u>20.1</u>
2	0.3972	QP	29.8	<u>32.7</u>	5.7	5.7	35.5	<u>38.4</u>	57.9	22.4	<u>19.5</u>
3	0.3972	AVG	29.7	<u>32.5</u>	5.7	5.7	35.4	<u>38.2</u>	47.9	12.5	<u>9.7</u>
4	0.5097	QP	27.2	<u>29.9</u>	5.8	5.7	33.0	<u>35.6</u>	56.0	23.0	<u>20.4</u>
5	1.1323	QP	21.0	<u>24.1</u>	5.9	5.9	26.9	<u>30.0</u>	56.0	29.1	<u>26.0</u>
6	4.7087	QP	21.4	20.1	5.9	5.8	27.3	25.9	56.0	28.7	30.1
7	8.4247	QP	<u>30.1</u>	29.2	6.0	6.0	<u>36.1</u>	35.2	60.0	<u>23.9</u>	24.8
8	20.6407	QP	22.0	21.4	6.3	6.6	28.3	28.0	60.0	31.7	32.0

Higher six points are underlined.
 Other frequencies : Below the FCC Part15B Class B limit
 Emission Level = Read + Factor(LISN,Pad,Cable)

9.2 Radiated Electric Field
 9.2.1 RX 0.030MHz mode (30 – 1000MHz)

ETL SEMKO Japan K.K
Kashima No.1 Test Site
Radiated Electric Field

APPLICANT : Vertex Standard Co., Ltd.
 EUT NAME : HF Transceiver
 MODEL NO. : FT-2000
 SERIAL NO. : 6G000001
 TEST MODE : RX 0.030MHz (ANT1)
 POWER SOURCE : AC120V/60Hz
 DATE TESTED : May 22 2006
 FILE NO. : ESJ-106074
 REGULATION : FCC Part15B Class B
 TEST METHOD : ANSI C63.4-2003
 DISTANCE : 3.00 [m]
 TEMPERATURE : 22.0 [degC]
 HUMIDITY : 51.0 [%]
 NOTE :

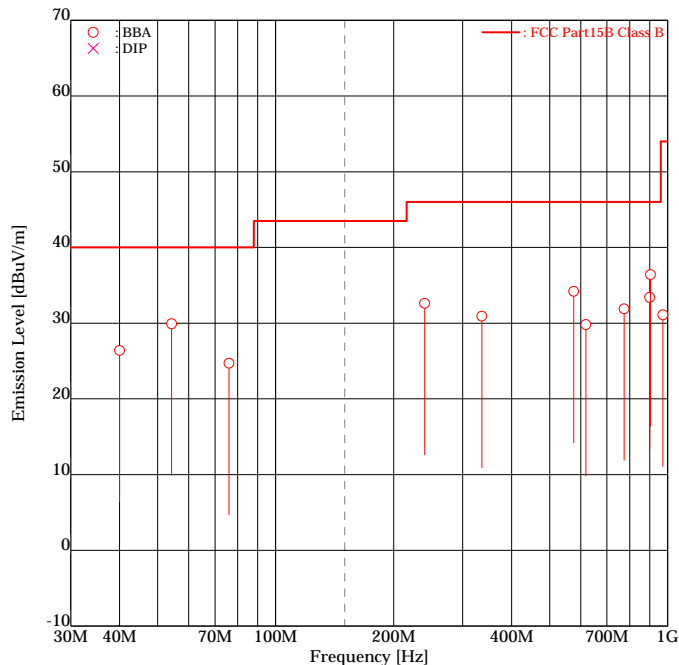

ENGINEER : Kazuo Masuda

FREQUENCY [No]	FREQ [MHz]	ANT.	READING [dBuV]		FACTOR [dB/m]		EMISSION [dBuV/m]		LIMIT [dBuV/m]		MARGIN [dB]	
			Hori	Vert	Hori	Vert	Hori	Vert	Hori	Vert	Hori	Vert
1	40.00	BBA	-	<u>34.3</u>	-7.9	-7.9	-	<u>26.4</u>	40.0	-	<u>13.6</u>	
2	54.25	BBA	-	<u>37.1</u>	-7.2	-7.2	-	<u>29.9</u>	40.0	-	<u>10.1</u>	
3	76.00	BBA	-	34.5	-9.8	-9.8	-	24.7	40.0	-	15.3	
4	240.01	BBA	<u>39.1</u>	38.0	-6.5	-6.5	<u>32.6</u>	31.5	46.0	<u>13.4</u>	14.5	
5	336.03	BBA	34.6	-	-3.7	-3.7	30.9	-	46.0	15.1	-	
6	576.05	BBA	<u>31.0</u>	-	3.2	3.2	<u>34.2</u>	-	46.0	<u>11.8</u>	-	
7	618.74	BBA	25.6	-	4.2	4.2	29.8	-	46.0	16.2	-	
8	774.14	BBA	24.6	-	7.3	7.3	31.9	-	46.0	14.1	-	
9	899.99	BBA	<u>23.6</u>	-	9.8	9.8	<u>33.4</u>	-	46.0	<u>12.6</u>	-	
10	904.09	BBA	<u>26.5</u>	24.7	9.9	9.9	<u>36.4</u>	34.6	46.0	<u>9.6</u>	11.4	
11	972.70	BBA	-	20.3	10.8	10.8	-	31.1	54.0	-	22.9	

Higher six points are underlined.
 Other frequencies : Below the FCC Part15B Class B limit
 Emission Level = Read + Factor(Antenna,Pad,Cable,Preamp)
 ANT. : Used antenna(BBA = Broadband antenna, DIP = Dipole antenna)

9.2.2 RX 0.030MHz mode (1000 – 2000MHz)

ETL SEMKO Japan K.K

Kashima No.1 Test Site

Radiated Electric Field

APPLICANT : Vertex Standard Co., Ltd.
 EUT NAME : HF Transceiver
 MODEL NO. : FT-2000
 SERIAL NO. : 6G000001
 TEST MODE : RX 0.030MHz (ANT1)
 POWER SOURCE : AC120V/60Hz
 DATE TESTED : May 23 2006
 FILE NO. : ESJ-106074
 REGULATION : FCC Part15B Class B
 TEST METHOD : ANSI C63.4-2003
 DISTANCE : 3.00 [m]
 TEMPERATURE : 21.0 [degC]
 HUMIDITY : 60.0 [%]
 NOTE :

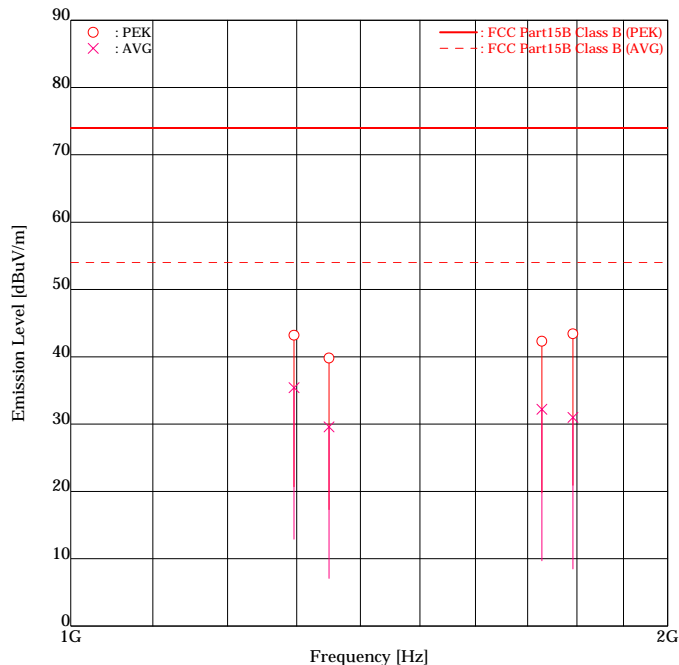

ENGINEER : Kazuo Masuda

FREQUENCY [No]	MODE [MHz]		READING [dBuV]		FACTOR [dB/m]		EMISSION [dBuV/m]		LIMIT [dBuV/m]		MARGIN [dB]	
			Hori	Vert	Hori	Vert	Hori	Vert	Hori	Vert	Hori	Vert
1	1296.12	PEK	<u>44.0</u>	42.8	-0.8	-0.8	<u>43.2</u>	42.0	74.0	<u>30.8</u>	32.0	
2	1296.12	AVG	<u>36.2</u>	33.2	-0.8	-0.8	<u>35.4</u>	32.4	54.0	<u>18.6</u>	21.6	
3	1349.98	PEK	40.5	-	-0.7	-0.7	39.8	-	74.0	34.2	-	
4	1349.98	AVG	<u>30.3</u>	-	-0.7	-0.7	<u>29.6</u>	-	54.0	<u>24.4</u>	-	
5	1728.15	PEK	41.1	-	1.2	1.2	42.3	-	74.0	31.7	-	
6	1728.15	AVG	<u>31.0</u>	-	1.2	1.2	<u>32.2</u>	-	54.0	<u>21.8</u>	-	
7	1791.52	PEK	-	<u>41.9</u>	1.5	1.5	-	<u>43.4</u>	74.0	-	<u>30.6</u>	
8	1791.52	AVG	-	<u>29.5</u>	1.5	1.5	-	<u>31.0</u>	54.0	-	<u>23.0</u>	

Higher six points are underlined.
 Other frequencies : Below the FCC Part15B Class B limit
 Emission Level = Read + Factor(Antenna, Antenna Pad, Cable, Preamp)
 ANT. : Used antenna (BBA = Broadband antenna, DIP = Dipole antenna)

9.2.3 RX 30MHz mode (30 – 1000MHz)

ETL SEMKO Japan K.K
Kashima No.1 Test Site
Radiated Electric Field

APPLICANT : Vertex Standard Co., Ltd.
 EUT NAME : HF Transceiver
 MODEL NO. : FT-2000
 SERIAL NO. : 6G000001
 TEST MODE : RX 30MHz (ANT1)
 POWER SOURCE : AC120V/60Hz
 DATE TESTED : May 22 2006
 FILE NO. : ESJ-106074
 REGULATION : FCC Part15B Class B
 TEST METHOD : ANSI C63.4-2003
 DISTANCE : 3.00 [m]
 TEMPERATURE : 22.0 [degC]
 HUMIDITY : 51.0 [%]
 NOTE :

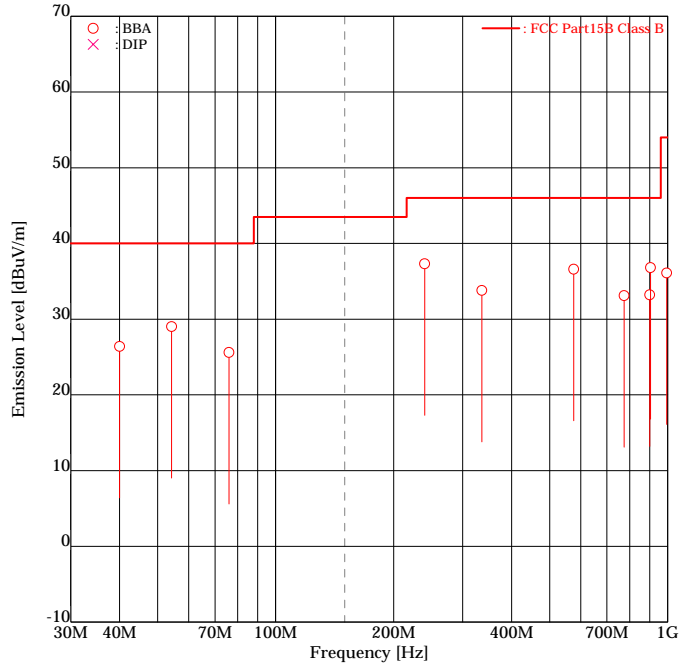

ENGINEER : Kazuo Masuda

FREQUENCY [No]	ANT. [MHz]	ANT.	READING [dBuV]		FACTOR [dB/m]		EMISSION [dBuV/m]		LIMIT [dBuV/m]		MARGIN [dB]	
			Hori	Vert	Hori	Vert	Hori	Vert	Hori	Vert	Hori	Vert
1	40.00	BBA	-	34.3	-7.9	-7.9	-	26.4	40.0	-	13.6	
2	54.28	BBA	-	<u>36.2</u>	-7.2	-7.2	-	<u>29.0</u>	40.0	-	<u>11.0</u>	
3	76.00	BBA	-	35.4	-9.8	-9.8	-	25.6	40.0	-	14.4	
4	240.01	BBA	<u>43.8</u>	39.2	-6.5	-6.5	<u>37.3</u>	32.7	46.0	8.7	13.3	
5	336.03	BBA	<u>37.5</u>	-	-3.7	-3.7	<u>33.8</u>	-	46.0	<u>12.2</u>	-	
6	576.05	BBA	<u>33.4</u>	31.2	3.2	3.2	<u>36.6</u>	34.4	46.0	<u>9.4</u>	11.6	
7	774.14	BBA	25.8	-	7.3	7.3	33.1	-	46.0	12.9	-	
8	899.99	BBA	<u>23.4</u>	-	9.8	9.8	<u>33.2</u>	-	46.0	<u>12.8</u>	-	
9	904.09	BBA	<u>26.9</u>	25.1	9.9	9.9	<u>36.8</u>	35.0	46.0	<u>9.2</u>	11.0	
10	994.50	BBA	-	25.0	11.1	11.1	-	36.1	54.0	-	17.9	

Higher six points are underlined.
 Other frequencies : Below the FCC Part15B Class B limit
 Emission Level = Read + Factor(Antenna,Pad,Cable,Preamp)
 ANT. : Used antenna(BBA = Broadband antenna, DIP = Dipole antenna)

9.2.4 RX 30MHz mode (1000 – 2000MHz)

ETL SEMKO Japan K.K
Kashima No.1 Test Site
Radiated Electric Field

APPLICANT : Vertex Standard Co., Ltd.
 EUT NAME : HF Transceiver
 MODEL NO. : FT-2000
 SERIAL NO. : 6G000001
 TEST MODE : RX 30MHz (ANT1)
 POWER SOURCE : AC120V/60Hz
 DATE TESTED : May 23 2006
 FILE NO. : ESJ-106074
 REGULATION : FCC Part15B Class B
 TEST METHOD : ANSI C63.4-2003
 DISTANCE : 3.00 [m]
 TEMPERATURE : 21.0 [degC]
 HUMIDITY : 60.0 [%]
 NOTE :

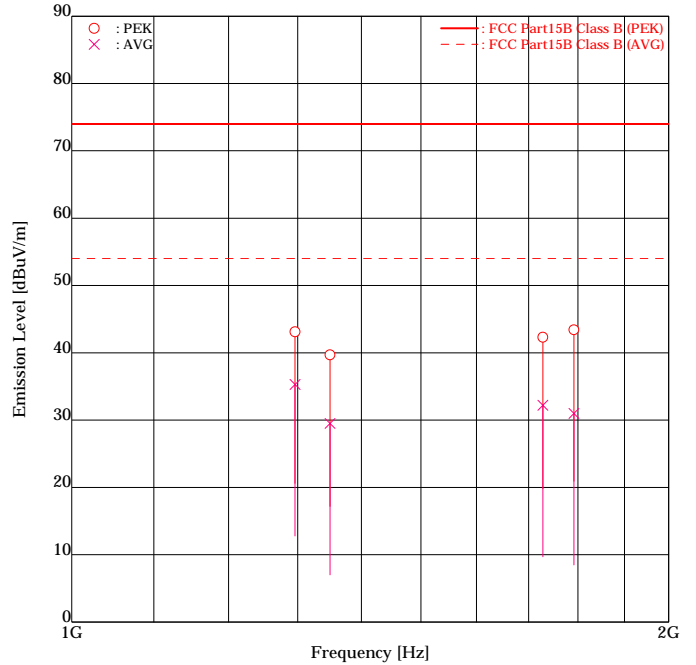

ENGINEER : Kazuo Masuda

FREQUENCY [No]	MODE [MHz]		READING [dBuV]		FACTOR [dB/m]		EMISSION [dBuV/m]		LIMIT [dBuV/m]		MARGIN [dB]	
			Hori	Vert	Hori	Vert	Hori	Vert	Hori	Vert		
1	1296.12	PEK	<u>43.9</u>	42.7	-0.8	-0.8	<u>43.1</u>	41.9	74.0	<u>30.9</u>	32.1	
2	1296.12	AVG	<u>36.1</u>	33.2	-0.8	-0.8	<u>35.3</u>	32.4	54.0	<u>18.7</u>	21.6	
3	1349.98	PEK	40.4	-	-0.7	-0.7	39.7	-	74.0	34.3	-	
4	1349.98	AVG	<u>30.2</u>	-	-0.7	-0.7	<u>29.5</u>	-	54.0	<u>24.5</u>	-	
5	1728.15	PEK	41.1	-	1.2	1.2	42.3	-	74.0	31.7	-	
6	1728.15	AVG	<u>31.0</u>	-	1.2	1.2	<u>32.2</u>	-	54.0	<u>21.8</u>	-	
7	1791.52	PEK	-	<u>41.9</u>	1.5	1.5	-	<u>43.4</u>	74.0	-	<u>30.6</u>	
8	1791.52	AVG	-	<u>29.5</u>	1.5	1.5	-	<u>31.0</u>	54.0	-	<u>23.0</u>	

Higher six points are underlined.
 Other frequencies : Below the FCC Part15B Class B limit
 Emission Level = Read + Factor(Antenna, Antenna Pad, Cable, Preamp)
 ANT. : Used antenna(BBA = Broadband antenna, DIP = Dipole antenna)

9.2.5 RX 60MHz mode (30 – 1000MHz)

ETL SEMKO Japan K.K

Kashima No.1 Test Site

Radiated Electric Field

APPLICANT : Vertex Standard Co., Ltd.
 EUT NAME : HF Transceiver
 MODEL NO. : FT-2000
 SERIAL NO. : 6G000001
 TEST MODE : RX 60MHz (ANT1)
 POWER SOURCE : AC120V/60Hz
 DATE TESTED : May 22 2006
 FILE NO. : ESJ-106074
 REGULATION : FCC Part15B Class B
 TEST METHOD : ANSI C63.4-2003
 DISTANCE : 3.00 [m]
 TEMPERATURE : 22.0 [degC]
 HUMIDITY : 51.0 [%]
 NOTE :

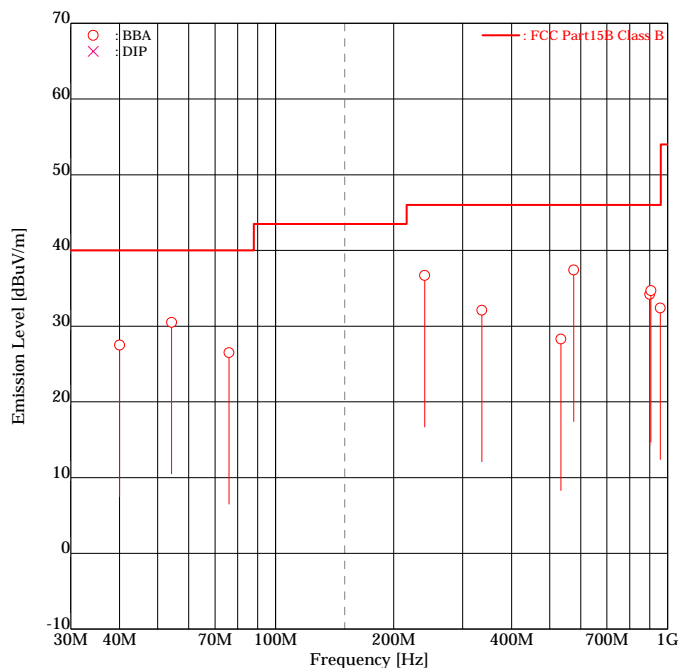

ENGINEER : Kazuo Masuda

FREQUENCY [No]	ANT. [MHz]	ANT.	READING [dBuV]		FACTOR [dB/m]		EMISSION [dBuV/m]		LIMIT [dBuV/m]		MARGIN [dB]	
			Hori	Vert	Hori	Vert	Hori	Vert	Hori	Vert	Hori	Vert
1	40.00	BBA	-	<u>35.4</u>	-7.9	-7.9	-	<u>27.5</u>	40.0	-	<u>12.5</u>	
2	54.27	BBA	-	<u>37.7</u>	-7.2	-7.2	-	<u>30.5</u>	40.0	-	<u>9.5</u>	
3	76.00	BBA	-	36.3	-9.8	-9.8	-	26.5	40.0	-	13.5	
4	240.01	BBA	<u>43.2</u>	-	-6.5	-6.5	<u>36.7</u>	-	46.0	<u>9.3</u>	-	
5	336.03	BBA	35.8	-	-3.7	-3.7	32.1	-	46.0	13.9	-	
6	534.53	BBA	-	26.2	2.1	2.1	-	28.3	46.0	-	17.7	
7	576.05	BBA	<u>34.2</u>	31.7	3.2	3.2	<u>37.4</u>	34.9	46.0	<u>8.6</u>	11.1	
8	899.99	BBA	23.4	<u>24.4</u>	9.8	9.8	33.2	<u>34.2</u>	46.0	12.8	<u>11.8</u>	
9	906.15	BBA	<u>24.9</u>	24.0	9.8	9.8	<u>34.7</u>	33.8	46.0	<u>11.3</u>	12.2	
10	958.46	BBA	-	22.0	10.4	10.4	-	32.4	46.0	-	13.6	

Higher six points are underlined.
 Other frequencies : Below the FCC Part15B Class B limit
 Emission Level = Read + Factor(Antenna,Pad,Cable,Preamp)
 ANT. : Used antenna(BBA = Broadband antenna, DIP = Dipole antenna)

9.2.6 RX 60MHz mode (1000 – 2000MHz)

ETL SEMKO Japan K.K
Kashima No.1 Test Site
Radiated Electric Field

APPLICANT : Vertex Standard Co., Ltd.
 EUT NAME : HF Transceiver
 MODEL NO. : FT-2000
 SERIAL NO. : 6G000001
 TEST MODE : RX 60MHz (ANT1)
 POWER SOURCE : AC120V/60Hz
 DATE TESTED : May 23 2006
 FILE NO. : ESJ-106074
 REGULATION : FCC Part15B Class B
 TEST METHOD : ANSI C63.4-2003
 DISTANCE : 3.00 [m]
 TEMPERATURE : 21.0 [degC]
 HUMIDITY : 60.0 [%]
 NOTE :

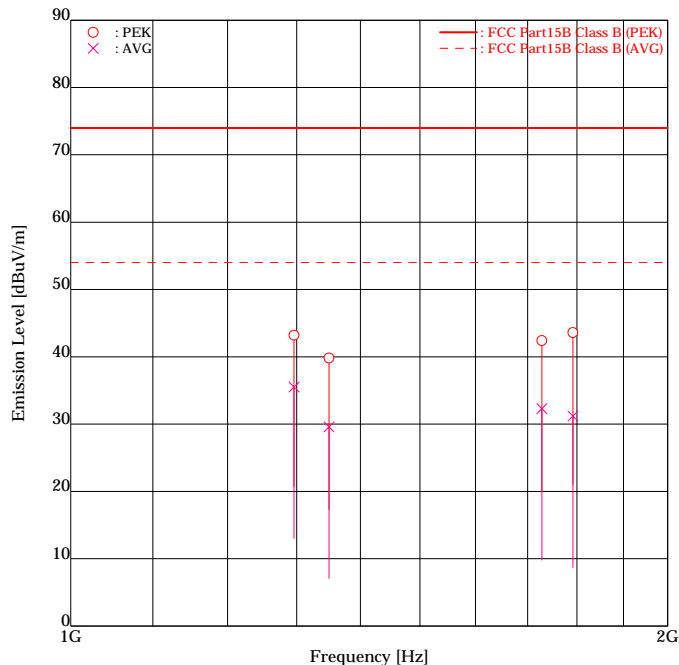

ENGINEER : Kazuo Masuda

FREQUENCY [No]	MODE	MODE	READING [dBuV]		FACTOR [dB/m]		EMISSION [dBuV/m]		LIMIT [dBuV/m]		MARGIN [dB]	
			Hori	Vert	Hori	Vert	Hori	Vert	Hori	Vert	Hori	Vert
1	1296.12	PEK	<u>44.0</u>	42.9	-0.8	-0.8	<u>43.2</u>	42.1	74.0	<u>30.8</u>	31.9	
2	1296.12	AVG	<u>36.3</u>	33.3	-0.8	-0.8	<u>35.5</u>	32.5	54.0	<u>18.5</u>	21.5	
3	1349.98	PEK	40.5	-	-0.7	-0.7	39.8	-	74.0	34.2	-	
4	1349.98	AVG	<u>30.3</u>	-	-0.7	-0.7	<u>29.6</u>	-	54.0	<u>24.4</u>	-	
5	1728.15	PEK	41.2	-	1.2	1.2	42.4	-	74.0	31.6	-	
6	1728.15	AVG	<u>31.1</u>	-	1.2	1.2	<u>32.3</u>	-	54.0	<u>21.7</u>	-	
7	1791.52	PEK	-	<u>42.1</u>	1.5	1.5	-	<u>43.6</u>	74.0	-	<u>30.4</u>	
8	1791.52	AVG	-	<u>29.7</u>	1.5	1.5	-	<u>31.2</u>	54.0	-	<u>22.8</u>	

Higher six points are underlined.
 Other frequencies : Below the FCC Part15B Class B limit
 Emission Level = Read + Factor(Antenna, Antenna Pad, Cable, Preamp)
 ANT. : Used antenna(BBA = Broadband antenna, DIP = Dipole antenna)

9.3 Conducted Power on Antenna Port
 9.3.1 RX 60MHz mode (30 – 1000MHz) : ANT1

ETL SEMKO Japan K.K
Kashima No.1 Test Site
Conducted Power on Antenna Port

APPLICANT : Vertex Standard Co., Ltd.
 EUT NAME : HF Transceiver
 MODEL NO. : FT-2000
 SERIAL NO. : 6G000001
 TEST MODE : RX 60MHz (ANT1)
 POWER SOURCE : AC120V/60Hz
 DATE TESTED : May 23 2006
 FILE NO. : ESJ-106074
 REGULATION : FCC Part15B (15.111)
 TEST METHOD : ANSI C63.4-2003
 TEMPERATURE : 21.0 [degC]
 HUMIDITY : 60.0 [%]
 NOTE :

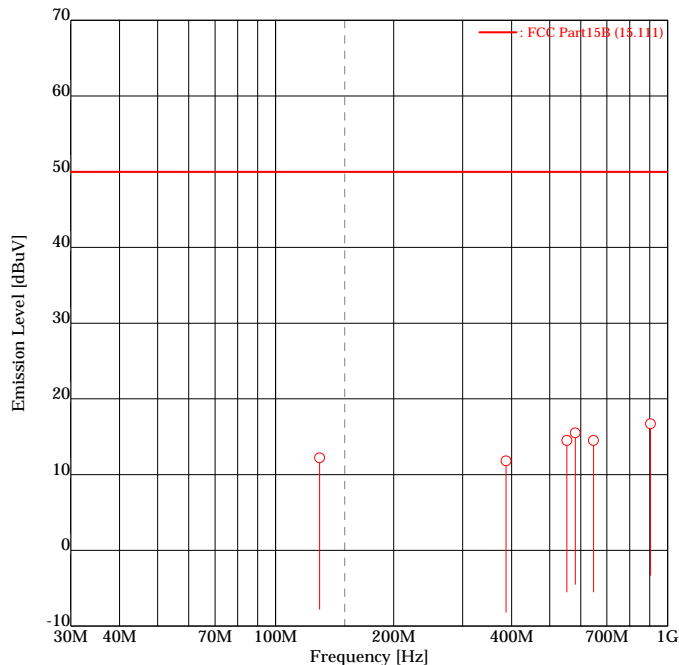

ENGINEER : Kazuo Masuda

FREQUENCY [No]	FREQUENCY [MHz]	READING [dBuV]	FACTOR [dB]	EMISSION [dBuV]	LIMIT [dBuV]	MARGIN [dB]
1	129.4500	<u>28.0</u>	-15.8	<u>12.2</u>	50.0	<u>37.8</u>
2	387.0700	<u>27.1</u>	-15.3	<u>11.8</u>	50.0	<u>38.2</u>
3	553.1200	<u>29.8</u>	-15.3	<u>14.5</u>	50.0	<u>35.5</u>
4	581.2400	<u>30.7</u>	-15.2	<u>15.5</u>	50.0	<u>34.5</u>
5	647.2500	<u>28.9</u>	-14.4	<u>14.5</u>	50.0	<u>35.5</u>
6	904.0900	<u>29.9</u>	-13.2	<u>16.7</u>	50.0	<u>33.3</u>

Higher six points are underlined.
 Other frequencies : Below the FCC Part15B (15.111) limit
 Emission Level = Read + Factor(Pad,Cable,Preamp)

9.3.2 RX 60MHz mode (1000 – 2000MHz) : ANT1

ETL SEMKO Japan K.K
Kashima No.1 Test Site
Conducted Power on Antenna Port

APPLICANT : Vertex Standard Co., Ltd.
 EUT NAME : HF Transceiver
 MODEL NO. : FT-2000
 SERIAL NO. : 6G000001
 TEST MODE : RX 60MHz (ANT1)
 POWER SOURCE : AC120V/60Hz
 DATE TESTED : May 23 2006
 FILE NO. : ESJ-106074
 REGULATION : FCC Part15B (15.111)
 TEST METHOD : ANSI C63.4-2003
 TEMPERATURE : 21.0 [degC]
 HUMIDITY : 60.0 [%]
 NOTE :

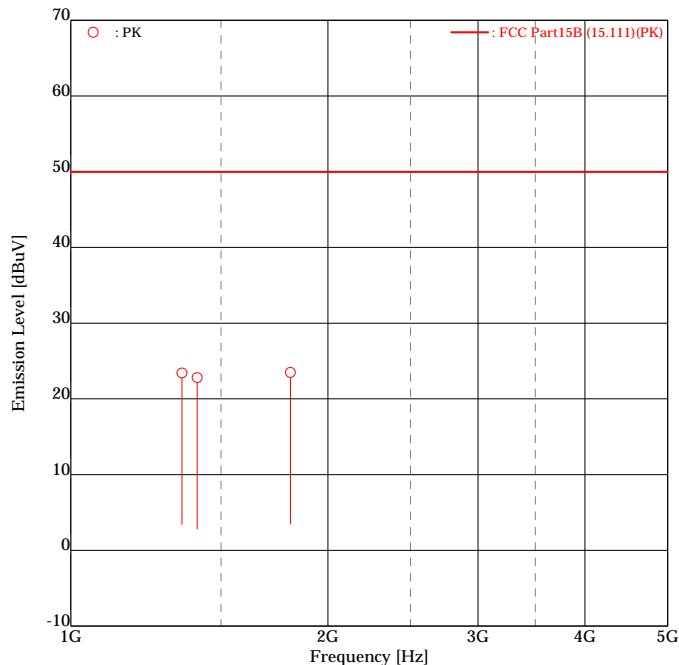

ENGINEER : Kazuo Masuda

FREQUENCY [No]	FREQUENCY [MHz]	READING [dBuV]	FACTOR [dB]	EMISSION [dBuV]	LIMIT [dBuV]	MARGIN [dB]
1	1349.9800	<u>42.3</u>	-18.9	<u>23.4</u>	50.0	<u>26.6</u>
2	1406.4000	<u>41.5</u>	-18.7	<u>22.8</u>	50.0	<u>27.2</u>
3	1808.2300	<u>41.8</u>	-18.3	<u>23.5</u>	50.0	<u>26.5</u>

Higher six points are underlined.
 Other frequencies : Below the FCC Part15B (15.111) limit
 Emission Level = Read + Factor(Pad,Cable,Preamp)

9.3.3 VFO Scan mode (ANT1)

< Graph number #1 >

SPECTRUM ANALYSIS

Kashima No.1 Test Site

22.0degC /67.0%

Date tested : May 24 2006
Company : Vertex Standard Co., Ltd.
EUT Name : HF Transceiver
Model number : FT-2000
Serial number : 6G000001

Test mode : VFO Scan (ANT1)
Power source : AC120V/60Hz
File number : ESJ-106074
Engineer : Kazuo Masuda
Note : Band : 0.030 - 60.000MHz

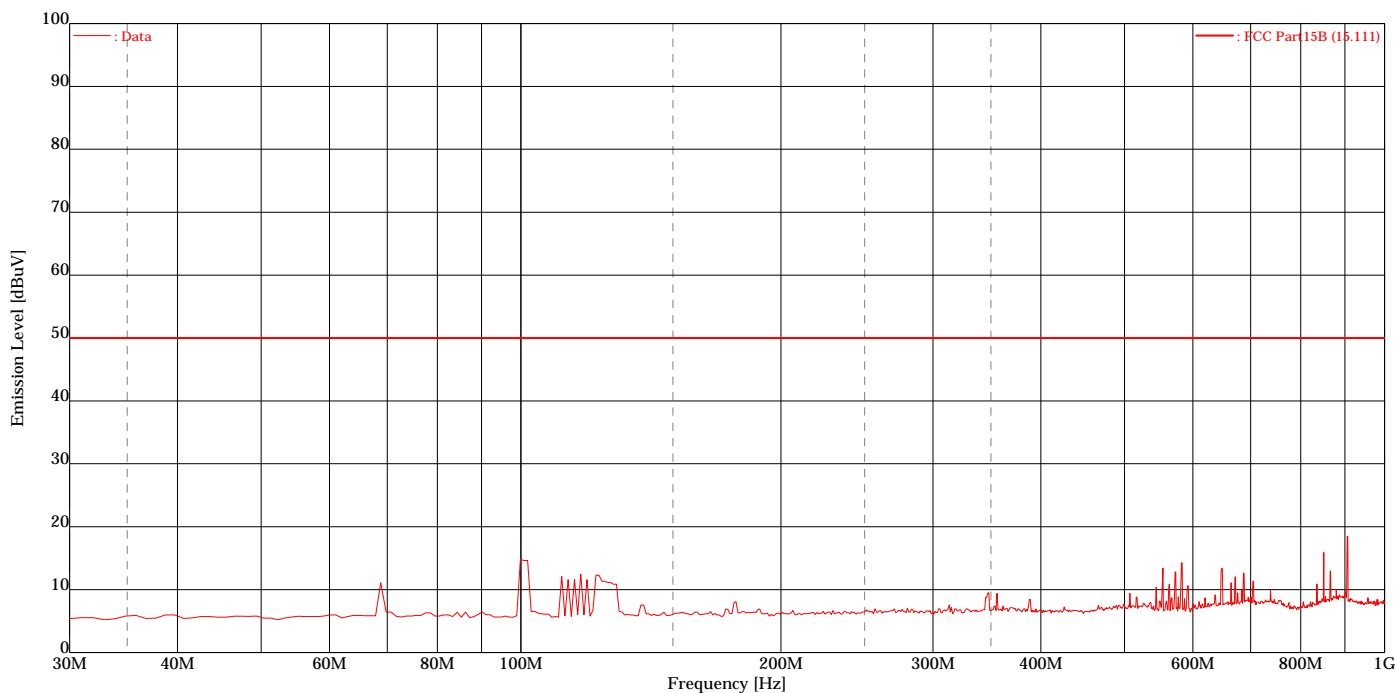

9.3.4 RX 60MHz mode (30 – 1000MHz) : ANT2

ETL SEMKO Japan K.K
Kashima No.1 Test Site
Conducted Power on Antenna Port

APPLICANT : Vertex Standard Co., Ltd.
 EUT NAME : HF Transceiver
 MODEL NO. : FT-2000
 SERIAL NO. : 6G000001
 TEST MODE : RX 60MHz (ANT2)
 POWER SOURCE : AC120V/60Hz
 DATE TESTED : May 23 2006
 FILE NO. : ESJ-106074
 REGULATION : FCC Part15B (15.111)
 TEST METHOD : ANSI C63.4-2003
 TEMPERATURE : 21.0 [degC]
 HUMIDITY : 60.0 [%]
 NOTE :

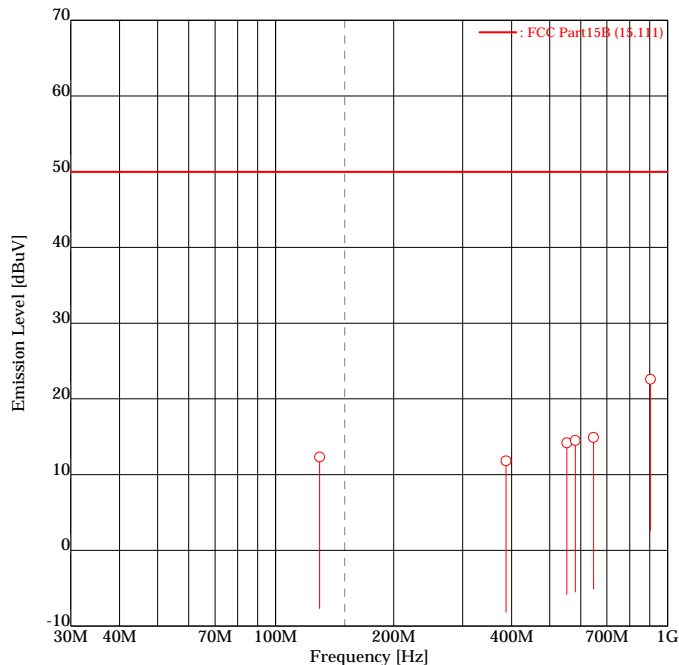

ENGINEER : Kazuo Masuda

FREQUENCY [No]	FREQUENCY [MHz]	READING [dBuV]	FACTOR [dB]	EMISSION [dBuV]	LIMIT [dBuV]	MARGIN [dB]
1	129.4500	<u>28.1</u>	-15.8	<u>12.3</u>	50.0	<u>37.7</u>
2	387.0700	<u>27.1</u>	-15.3	<u>11.8</u>	50.0	<u>38.2</u>
3	553.1200	<u>29.5</u>	-15.3	<u>14.2</u>	50.0	<u>35.8</u>
4	581.2400	<u>29.7</u>	-15.2	<u>14.5</u>	50.0	<u>35.5</u>
5	647.2500	<u>29.3</u>	-14.4	<u>14.9</u>	50.0	<u>35.1</u>
6	904.0900	<u>35.8</u>	-13.2	<u>22.6</u>	50.0	<u>27.4</u>

Higher six points are underlined.
 Other frequencies : Below the FCC Part15B (15.111) limit
 Emission Level = Read + Factor(Pad,Cable,Preamp)

9.3.5 RX 60MHz mode (1000 – 2000MHz) : ANT2

ETL SEMKO Japan K.K
Kashima No.1 Test Site
Conducted Power on Antenna Port

APPLICANT : Vertex Standard Co., Ltd.
 EUT NAME : HF Transceiver
 MODEL NO. : FT-2000
 SERIAL NO. : 6G000001
 TEST MODE : RX 60MHz (ANT2)
 POWER SOURCE : AC120V/60Hz
 DATE TESTED : May 23 2006
 FILE NO. : ESJ-106074
 REGULATION : FCC Part15B (15.111)
 TEST METHOD : ANSI C63.4-2003
 TEMPERATURE : 21.0 [degC]
 HUMIDITY : 60.0 [%]
 NOTE :

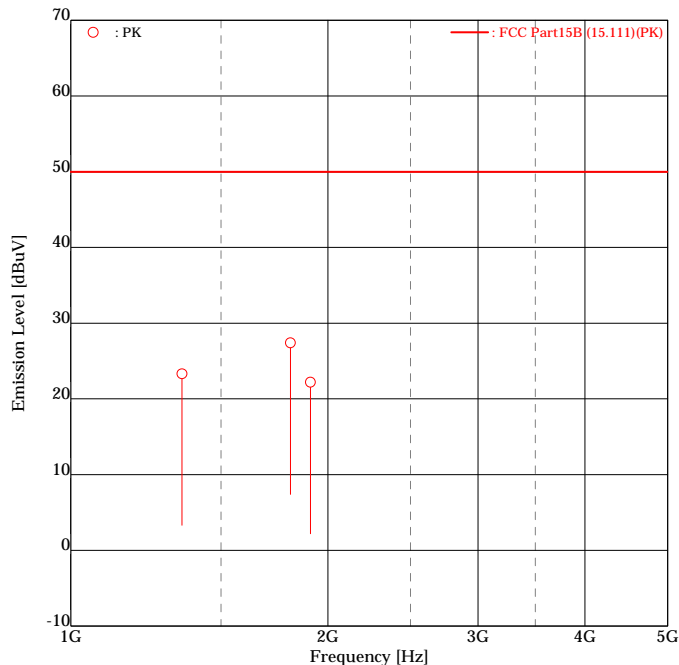

ENGINEER : Kazuo Masuda

FREQUENCY [No]	FREQUENCY [MHz]	READING [dBuV]	FACTOR [dB]	EMISSION [dBuV]	LIMIT [dBuV]	MARGIN [dB]
1	1350.0300	<u>42.2</u>	-18.9	<u>23.3</u>	50.0	<u>26.7</u>
2	1808.2400	<u>45.7</u>	-18.3	<u>27.4</u>	50.0	<u>22.6</u>
3	1908.8500	<u>40.5</u>	-18.3	<u>22.2</u>	50.0	<u>27.8</u>

Higher six points are underlined.
 Other frequencies : Below the FCC Part15B (15.111) limit
 Emission Level = Read + Factor(Pad,Cable,Preamp)

9.3.6 VFO Scan mode (ANT2)

< Graph number #2 >

SPECTRUM ANALYSIS

Kashima No.1 Test Site

22.0degC /67.0%

Date tested : May 24 2006
Company : Vertex Standard Co., Ltd.
EUT Name : HF Transceiver
Model number : FT-2000
Serial number : 6G000001

Test mode : VFO Scan (ANT2)
Power source : AC120V/60Hz
File number : ESJ-106074
Engineer : Kazuo Masuda
Note : Band : 0.030 - 60.000MHz

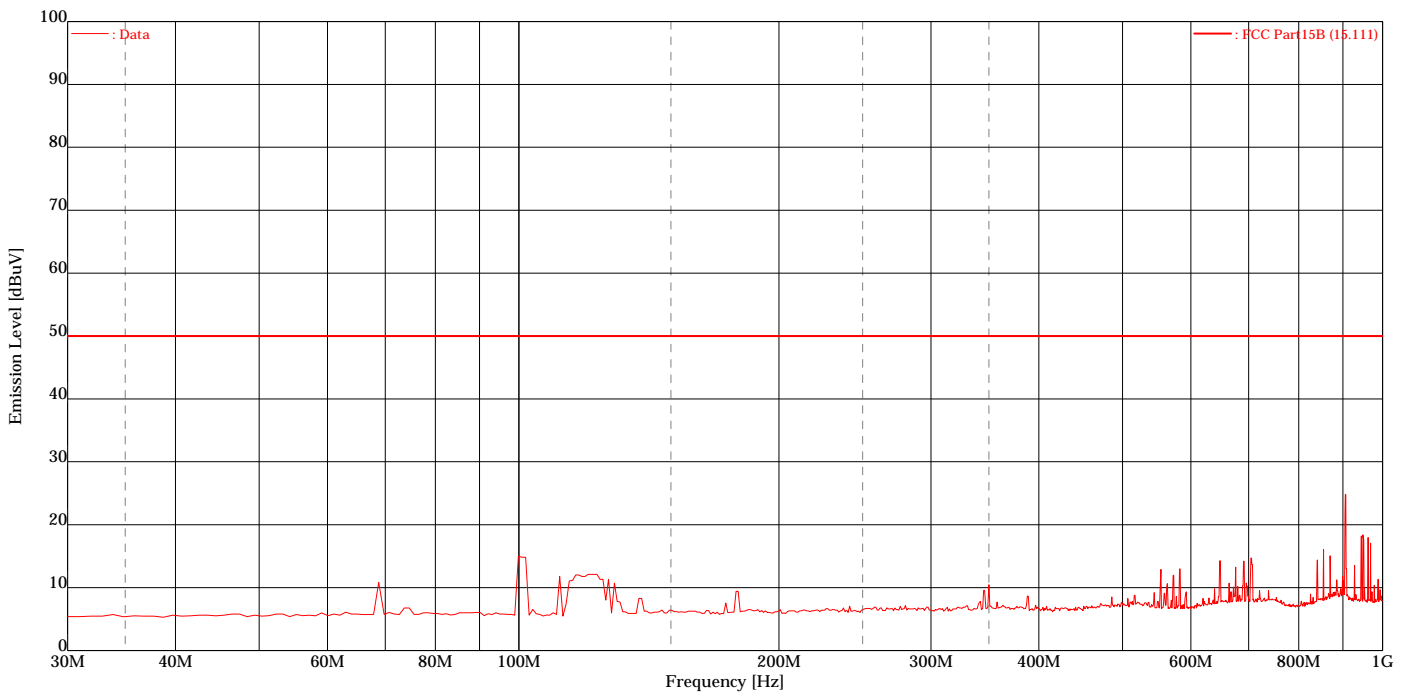

9.3.7 RX 60MHz mode (30 – 1000MHz) : ANT_RX

ETL SEMKO Japan K.K
Kashima No.1 Test Site
Conducted Power on Antenna Port

APPLICANT : Vertex Standard Co., Ltd.
 EUT NAME : HF Transceiver
 MODEL NO. : FT-2000
 SERIAL NO. : 6G000001
 TEST MODE : RX 60MHz (ANT_RX)
 POWER SOURCE : AC120V/60Hz
 DATE TESTED : May 23 2006
 FILE NO. : ESJ-106074
 REGULATION : FCC Part15B (15.111)
 TEST METHOD : ANSI C63.4-2003
 TEMPERATURE : 21.0 [degC]
 HUMIDITY : 60.0 [%]
 NOTE :

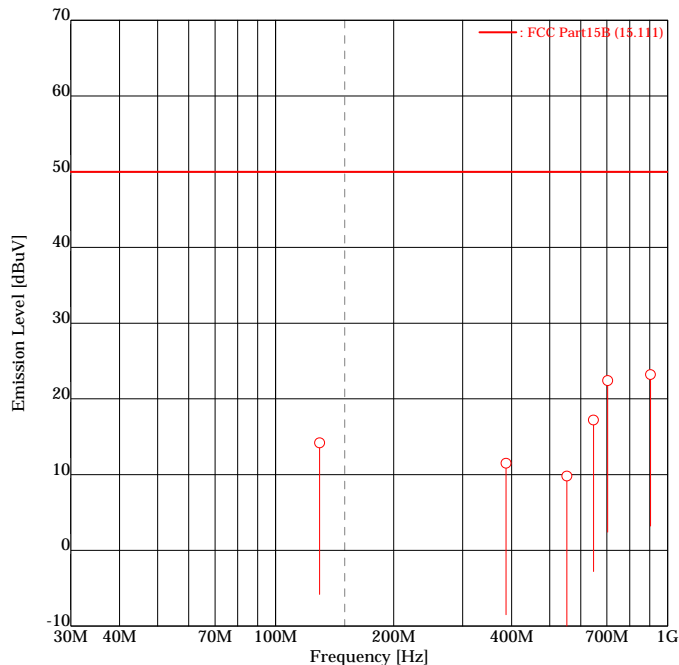

ENGINEER : Kazuo Masuda

FREQUENCY [No]	FREQUENCY [MHz]	READING [dBuV]	FACTOR [dB]	EMISSION [dBuV]	LIMIT [dBuV]	MARGIN [dB]
1	129.4500	<u>30.0</u>	-15.8	<u>14.2</u>	50.0	<u>35.8</u>
2	387.0700	<u>26.8</u>	-15.3	<u>11.5</u>	50.0	<u>38.5</u>
3	553.1200	<u>25.1</u>	-15.3	<u>9.8</u>	50.0	<u>40.2</u>
4	647.2500	<u>31.6</u>	-14.4	<u>17.2</u>	50.0	<u>32.8</u>
5	703.1800	<u>36.4</u>	-14.0	<u>22.4</u>	50.0	<u>27.6</u>
6	904.0900	<u>36.4</u>	-13.2	<u>23.2</u>	50.0	<u>26.8</u>

Higher six points are underlined.
 Other frequencies : Below the FCC Part15B (15.111) limit
 Emission Level = Read + Factor(Pad,Cable,Preamp)

9.3.8 RX 60MHz mode (1000 – 2000MHz) : ANT_RX

ETL SEMKO Japan K.K
Kashima No.1 Test Site
Conducted Power on Antenna Port

APPLICANT : Vertex Standard Co., Ltd.
 EUT NAME : HF Transceiver
 MODEL NO. : FT-2000
 SERIAL NO. : 6G000001
 TEST MODE : RX 60MHz (ANT_RX)
 POWER SOURCE : AC120V/60Hz
 DATE TESTED : May 23 2006
 FILE NO. : ESJ-106074
 REGULATION : FCC Part15B (15.111)
 TEST METHOD : ANSI C63.4-2003
 TEMPERATURE : 21.0 [degC]
 HUMIDITY : 60.0 [%]
 NOTE :

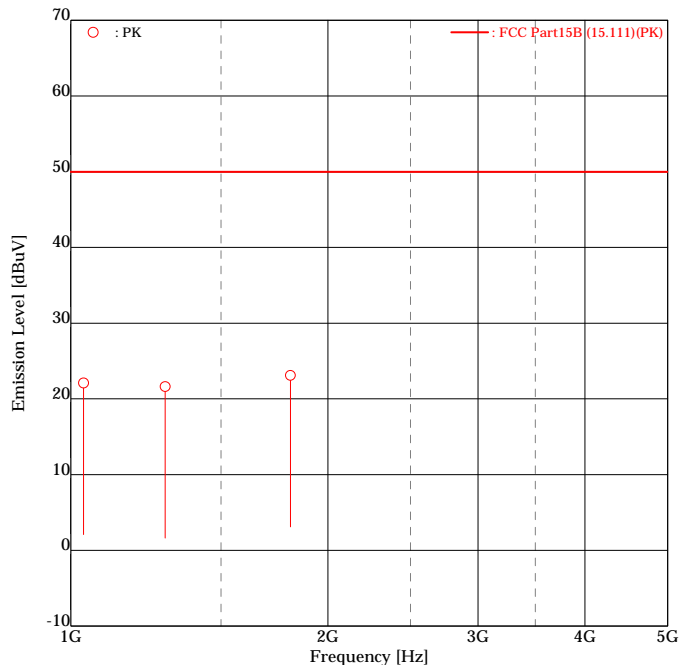

ENGINEER : Kazuo Masuda

FREQUENCY [No]	FREQUENCY [MHz]	READING [dBuV]	FACTOR [dB]	EMISSION [dBuV]	LIMIT [dBuV]	MARGIN [dB]
1	1035.6500	<u>41.8</u>	-19.7	<u>22.1</u>	50.0	<u>27.9</u>
2	1290.3300	<u>40.6</u>	-19.0	<u>21.6</u>	50.0	<u>28.4</u>
3	1808.3600	<u>41.4</u>	-18.3	<u>23.1</u>	50.0	<u>26.9</u>

Higher six points are underlined.
 Other frequencies : Below the FCC Part15B (15.111) limit
 Emission Level = Read + Factor(Pad,Cable,Preamp)

9.3.9 VFO Scan mode (ANT_RX)

< Graph number #3 >

SPECTRUM ANALYSIS

Kashima No.1 Test Site

22.0degC /67.0%

Date tested : May 24 2006
Company : Vertex Standard Co., Ltd.
EUT Name : HF Transceiver
Model number : FT-2000
Serial number : 6G000001

Test mode : VFO Scan (ANT_RX)
Power source : AC120V/60Hz
File number : ESJ-106074
Engineer : Kazuo Masuda
Note : Band : 0.030 - 60.000MHz

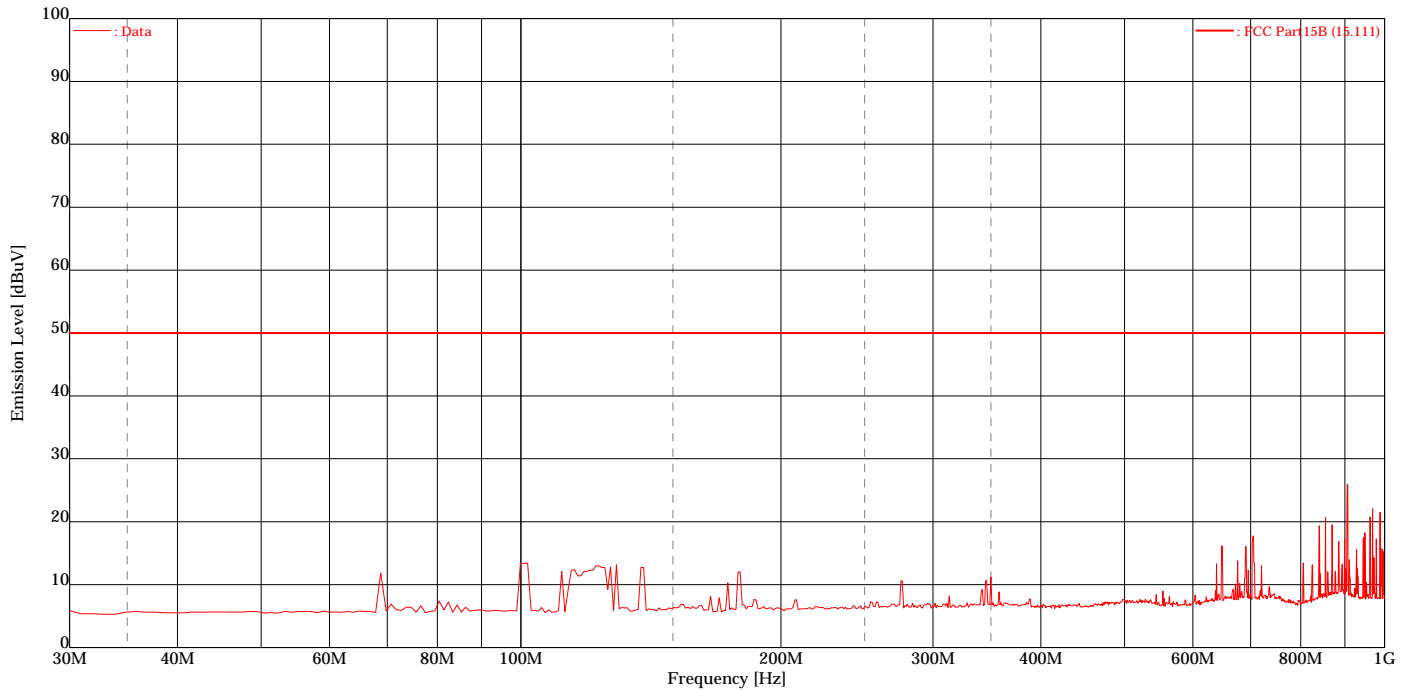

9.4 38dB Rejection Test

9.4.1 VFO Scan mode (ANT1)

Location : Kashima No.1 Test Site
 Date Tested : May. 24, 2006
 Temperature : 22 [degC]
 Humidity : 67 [%]
 Engineer : Kazuo Masuda

Injected Frequency [MHz]	Detected Frequency [MHz]	12dB SINAD Reading Injected Frequency [dBm]	12dB SINAD Reading Detected Frequency [dBm]	Rejection Level [dB]	Margin [dB]
824.040	No Point Detected	N / A	N / A	N / A	N / A
836.505	No Point Detected	N / A	N / A	N / A	N / A
848.970	No Point Detected	N / A	N / A	N / A	N / A
869.040	No Point Detected	N / A	N / A	N / A	N / A
881.505	No Point Detected	N / A	N / A	N / A	N / A
893.970	No Point Detected	N / A	N / A	N / A	N / A

The Audio Analyzer condition :
 12dB SINAD measurement level = 550mV.

9.4.2 VFO Scan mode (ANT2)

Location : Kashima No.1 Test Site
 Date Tested : May. 24, 2006
 Temperature : 22 [degC]
 Humidity : 67 [%]
 Engineer : Kazuo Masuda

Injected Frequency [MHz]	Detected Frequency [MHz]	12dB SINAD Reading Injected Frequency [dBm]	12dB SINAD Reading Detected Frequency [dBm]	Rejection Level [dB]	Margin [dB]
824.040	No Point Detected	N / A	N / A	N / A	N / A
836.505	No Point Detected	N / A	N / A	N / A	N / A
848.970	No Point Detected	N / A	N / A	N / A	N / A
869.040	No Point Detected	N / A	N / A	N / A	N / A
881.505	No Point Detected	N / A	N / A	N / A	N / A
893.970	No Point Detected	N / A	N / A	N / A	N / A

The Audio Analyzer condition :
 12dB SINAD measurement level = 550mV.

9.4.3 VFO Scan mode (ANT_RX)

Location : Kashima No.1 Test Site
 Date Tested : May. 24, 2006
 Temperature : 22 [degC]
 Humidity : 67 [%]
 Engineer : Kazuo Masuda

Injected Frequency [MHz]	Detected Frequency [MHz]	12dB SINAD Reading Injected Frequency [dBm]	12dB SINAD Reading Detected Frequency [dBm]	Rejection Level [dB]	Margin [dB]
824.040	No Point Detected	N / A	N / A	N / A	N / A
836.505	No Point Detected	N / A	N / A	N / A	N / A
848.970	No Point Detected	N / A	N / A	N / A	N / A
869.040	No Point Detected	N / A	N / A	N / A	N / A
881.505	No Point Detected	N / A	N / A	N / A	N / A
893.970	No Point Detected	N / A	N / A	N / A	N / A

The Audio Analyzer condition :
 12dB SINAD measurement level = 550mV.

9.5 Sample Calculations

9.5.1 Conducted Voltages on Mains Port

Example @ 0.3975MHz (AV)

Emission Level	=	Meter Reading		32.8	dBuV
	+	Factor	+	5.7	dB
			=	38.5	dBuV
Margin	=	Limit		47.9	dBuV
	-	Emission Level	-	38.5	dBuV
			=	9.4	dB

Factor = LISN Factor + Cable Loss + Pad Loss

9.5.2 Radiated Electric Field

Example @ 576.05MHz

Emission Level	=	Meter Reading		34.2	dBuV
	+	Factor	+	3.2	dB/m
			=	37.4	dBuV/m
Margin	=	Limit		46.0	dBuV/m
	-	Emission Level	-	37.4	dBuV/m
			=	8.6	dB

Factor = Antenna Factor + Cable Loss + Amplifier Gain + Pad Loss

9.5.3 Conducted Power on Antenna Port

Example @ 1808.24MHz

Output Power Level	=	Meter Reading		45.7	dBuV
	+	Factor	+	-18.3	dB
			=	27.4	dBuV
Margin	=	Limit (:2.0nW)		50.0	dBuV
	-	Output Power Level	-	27.4	dBuV
			=	22.6	dB

Factor = Cable Loss + Amplifier Gain + Pad Loss

9.5.4 38dB Rejection

Example @ N/A MHz

Rejection Level	=	12dB SINAD Reading at Injected Frequency		N/A	dBm
	-	12dB SINAD Reading at Detected Frequency	-	N/A	dBm
			=	N/A	dB
Margin	=	Rejection Level		N/A	dB
	-	Limit	-	38.0	dB
			=	N/A	dB

SECTION 10. LIST OF MEASURING INSTRUMENTS

Instrument	Model No.	Serial No.	Manufacturer	Cal. Date	Calibration Expired
LISN (EUT)	ESH2-Z5	882395/022	Rohde & Schwarz	Sep. 30, 05	Sep. 30, 06
6dB Attenuator	CFA-01	None	TME	Nov. 01, 05	Nov. 30, 06
LISN (Peripheral)	KNW-242	8-851-21	Kyoritsu	Feb. 06, 06	Feb. 28, 07
50Ω Termination	CT-01	A010CON50	TME	Oct. 18, 05	Oct. 31, 06
Coaxial cable	5D-2W(7.0 m)	C1	ETL SEMKO	Nov. 01, 05	Nov. 30, 06
Coaxial cable	5D-2W(2.0 m)	C2	ETL SEMKO	Nov. 01, 05	Nov. 30, 06
Coaxial cable	5D-2W(1.0 m)	R6	ETL SEMKO	Nov. 01, 05	Nov. 30, 06
Coaxial cable	5D-2W(1.0 m)	R7	ETL SEMKO	Nov. 01, 05	Nov. 30, 06
Tri-Log antenna	VULB9168	106	Schwarzbeck	Mar. 08, 06	Mar. 31, 07
6dB Attenuator	MP721B	M57593	Anritsu	Nov. 01, 05	Nov. 30, 06
Step Attenuator	8494B	2726A14513	Hewlett Packard	Nov. 01, 05	Nov. 30, 06
Amplifier	8447D	1937A03130	Hewlett Packard	Nov. 01, 05	Nov. 30, 06
Double Ridged Antenna	3115	9612-5044	EMCO	Jun. 13, 05	Jun. 30, 06
3dB Attenuator	4768-3	79	narda	Sep. 28, 05	Sep. 30, 06
Amplifier	83051A	3332A00329	Hewlett Packard	Sep. 28, 05	Sep. 30, 06
Coaxial cable	5D-2W(9.0 m)	R1	ETL SEMKO	Nov. 01, 05	Nov. 30, 06
Coaxial cable	10D-2W(5.5 m)	R2	ETL SEMKO	Nov. 01, 05	Nov. 30, 06
Coaxial cable	5D-2W(2.0 m)	R3	ETL SEMKO	Nov. 01, 05	Nov. 30, 06
Coaxial cable	5D-2W(0.2 m)	R4	ETL SEMKO	Nov. 01, 05	Nov. 30, 06
Coaxial cable	5D-2W(1.0 m)	R5	ETL SEMKO	Nov. 01, 05	Nov. 30, 06
Coaxial cable	5D-2W(1.0 m)	R6	ETL SEMKO	Nov. 01, 05	Nov. 30, 06
Coaxial cable	5D-2W(1.0 m)	R7	ETL SEMKO	Nov. 01, 05	Nov. 30, 06
Coaxial cable	SUCOFLEX102(1.0m)	R14 712/2	SUHNER	Sep. 28, 05	Sep. 30, 06
Coaxial cable	KPS-1501-1969-KPS(5.0m)	R15 04102003	Insulated Wire	Sep. 28, 05	Sep. 30, 06
Spectrum Analyzer	8564E	3643A00665	Hewlett Packard	Aug. 18, 05	Aug. 31, 06
Site Attenuation				Jun. 03, 05	Jun. 30, 06
Test receiver	ESS (Firmware Version 1.07)	847151/012	Rohde & Schwarz	Jan. 26, 06	Jan. 31, 07
RF Switch	ACX-150-1	None	ETL SEMKO	Nov. 01, 05	Nov. 30, 06
Testing Software : emiT (Version 2.0.0.0)					

Instrument	Model No.	Serial No.	Manufacturer	Cal. Date	Calibration Expired
Attenuator (10dB)	CFA05NP-10	262843	TME	Jul. 07, 05	Jul. 31, 06
RF Signal Generator	8657B	3247U03266	Hewlett Packard	Apr. 10, 06	Apr. 30, 07
Audio Analyzer	8903B	2948A07326	Kyoritsu	Apr. 18, 06	Apr. 30, 07
ANT Termination	MP752A	M65225	Anritsu	N.A.	N.A.
ANT Termination	MP752A	M61773	Anritsu	N.A.	N.A.
ANT Termination	CFA-01	None (×2)	TME	N.A.	N.A.

Note : Test instruments are calibrated according to Quality Manual and Calibration Rules of ETL SEMKO Japan.

SECTION 11. MEASUREMENT UNCERTAINTY

The uncertainty of the measurements performed for this report lies:

Radiated Electric Field at 3m		
30 MHz – 1000 MHz	± 4.5 dB	
Above 1 GHz	± 4.1 dB	
Radiated Electric Field at 10m		
30 MHz – 1000 MHz	± 4.7 dB	
Above 1 GHz	± 4.1 dB	
Radiated Electric Field at 30m		
Under consideration		
Radiated Effective Power		
11.7 GHz – 12.7 GHz	± 3.8 dB	
Conducted Voltages on Mains Port		
9 kHz – 30 MHz	± 3.0 dB	
Conducted Voltages on Telecommunication Port		
9 kHz – 30 MHz	± 3.4 dB	
Conducted Current on Telecommunication Port		
9 kHz – 30 MHz	± 1.3 dB	
Conducted Voltages on Terminals		
150 kHz – 30 MHz	± 1.0 dB	
Radiated Power		
30 MHz – 300 MHz	± 3.3 dB	

Note on Radiated Electric Field measurement uncertainty

The following items are not included in the calculations in spite of their own uncertainty components because it is impracticable to find the value.

It is our problem awaiting solution in future.

(1) Repeatability of measurement

It is not possible to calculate repeatability since the measurement was carried out only one time.

(2) Antenna factor variation

The definition of measured (radiated electric field strength) is not completed on the referred standard(s).



(3) Loss of EUT radiation propagation





It is certainly one of the uncertainty components, however is not able to calculate.

Please note that these uncertainties are not reflected to the compliance judgment of the test results in this report.

SECTION 12. DESCRIPTION OF TEST LABORATORY

ETL SEMKO is a division of Intertek plc (LSE: ITRK), a global leader in testing, inspection and certification services, operating in 273 laboratories and 521 offices in 100 countries throughout the world. The ETL SEMKO division of Intertek provides access to global markets through its local services, which include product safety testing and certification, EMC testing and performance testing for customers in such industries as wireless technology, security, appliances, HVAC, cables and wiring accessories, industrial machinery, medical devices, telecommunications, lighting, automotive, semiconductor, building products and electronics.

ACCREDITATION	SCOPE	LAB. CODE
 NVLAP USA <small>LAB CODE 100290-0</small>	EMC Testing	100290-0
 VLAC JAPAN	EMC Testing	VLAC-008-1
 BSMI TAIWAN	EMC Testing	SL2-IN-E-6008

FILING	SCOPE	LAB. CODE
 VCCI JAPAN	EMC Testing	-
 FCC USA	EMC Testing	Registration Number 934283
 IC CANADA	EMC Testing Telecom Testing	IC 2065
 SASO SAUDI ARABIA	EMC Testing	-